

DUKANE

User's Manual

Projector

8965WUSS

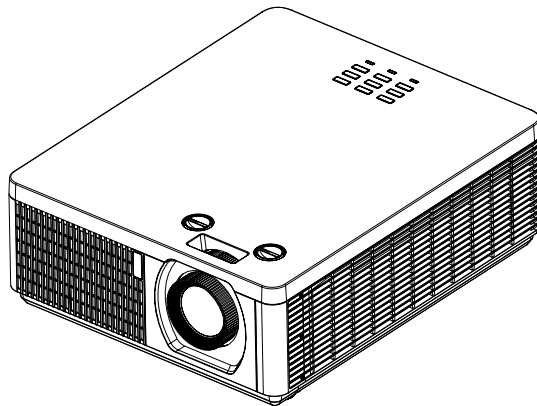

Thank you for purchasing this product.
Please read this manual before using the product.
Store it for future reference.

INDEX

Warning, Notices and Safety Instructions	4	OSD menu tree	46
Projector parts and functions	17	OSD description	50
Front view	17	Image	50
LED Indicator	17	Display Mode	50
Rear view	18	Brightness	51
Projector keypad	18	Contrast	51
I/O Port (Input / Output)	19	Computer	52
Bottom view	20	Auto Image	53
		Advanced	53
		Color Manager	55
Remote control	21	Settings 1	56
Range of effective remote control signal reception	23	Source	56
Installing batteries in the remote control	23	Projection	56
		Aspect Ratio	57
		Keystone	57
		Digital Zoom	57
		Audio	57
		Advanced 1	58
		Advanced 2	59
		4 Corner	59
		Settings 2	60
		Auto Source	60
		No Signal Power Off	60
		Auto Power On	60
		Laser Mode	60
		Reset All	61
		Status	61
		Advanced 1	61
		Advanced 2	70
		Custom Light	70
Projector installation	25		
Throw distance	25	Cleaning	71
Modes of installation	25	Cleaning the cabinet	71
Projection	25	Cleaning the lens	71
Horizontal and vertical lens shift	27		
Lens shift	27	Using the Kensington® lock	72
Moving the lens vertically	29		
Moving the lens horizontally	29	Simple troubleshooting	73
Connecting the projector	30	LED status	74
HDMI / MHL / DVI connection	30		
RGB connection	31	Specifications	76
HDBaseT connection	32	Specifications	76
RJ45 connection	33	Supported signal input modes	77
USB POWER (5V/1.5A) connection	33	MHL timing format	79
3D SYNC connection	34	3D timing format	79
VIDEO connection	34	Dimensions	80
SERVICE connection	35		
RS232C connection	35		
Audio IN (L/R) connection	36		
Audio OUT (Mini jack) connection	36		
Audio IN (Mini jack) connection	37		
Powering the projector on or off	38		
Powering on the projector	38		
Connect the power cord to the projector	38		
Turning off the projector	38		
Selecting an input source	39		
Setting an access password (security lock)	40		
Choosing a location	42		
Adjusting the projector's angle	43		
Adjusting the projector's zoom and focus	43		
Zoom	43		
Focus	44		
Correcting keystone	45		

Communication settings	81
RS-232 communication	81
Connection	81
Command control via the network	83
Connection	83
Communication port	83
Command control settings	84
Communication command table	84
PJLink command	96
Projection distance vs projection size table	97
Copyright information	98
Copyright	98
Trademark	98
Warranty and after-service	98

Warning, Notices and Safety Instructions

Warning, Notices and Safety Instructions

Notice

This product is intended for the adults who have the ability to operate this machine.

Please write down your projector model number and serial number and keep the information for maintenance purposes in the future. Should the equipment be lost or stolen, the information could also be used for the police report.

Model number:

Serial number:

Please check the accessories that come with the projector with the following list. Should you find any missing accessory, contact your dealer immediately.

1. AC Power Cord
2. Remote control
3. AAA battery 2pcs
4. RGB cable
5. 3D Sync cable 1pcs

Do not open

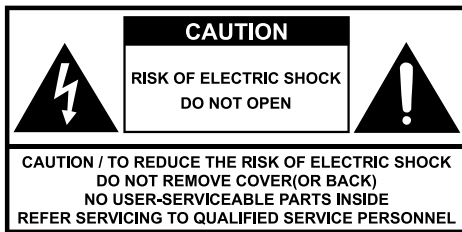

The lightning flash with an arrowhead within a triangle is intended to tell the user that inside this product may cause risk of electrical shock to persons.



The exclamation point within a triangle is intended to tell the user that important operating and/or servicing instructions are included in the technical documentation for this equipment.

About Electro-Magnetic Interference

This is a Class A product. In a domestic environment this product may cause radio interference in which case the user may be required to take adequate measures.

This product may cause interference if used in residential areas. Such use must be avoided unless the user takes special measures to reduce electromagnetic emissions to prevent interference to the reception of radio and television broadcasts.

Description pertaining to FCC Rules Part 15

This device complies with Part 15 of the FCC Rules. Operation is subject to the following two conditions: (1) this device may not cause harmful interference, and (2) this device must accept any interference received, including interference that may cause undesired operation.

This device has been tested and found to comply with the limits for a Class A digital device, pursuant to Part 15 of the FCC Rules. These limits are designed to provide reasonable protection against harmful interference in a residential installation.

This equipment generates, uses and can radiate radio frequency energy. If not installed and used in accordance with the instructions, may cause harmful interference to radio or television reception. Operation of this equipment in a residential area is likely to cause harmful interference in which case.

Warning, Notices and Safety Instructions

The user will be required to correct the interference at his own expense.

Caution: Changes or modifications not expressly approved by the manufacturer void the user's authority to operate the equipment.

CAN ICES-3(A) / NMB-3(A)

Information for users applicable in European Union countries

Disposal of Old Equipment and Batteries Only for European Union and countries with recycling systems

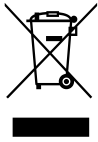

The above mark is in compliance with the Waste Electrical and Electronic Equipment Directive 2012/19/EU (WEEE).

The mark indicates the requirement NOT to dispose the equipment including any spent or discarded batteries as unsorted municipal waste, but use the return and collection systems available.

If the batteries or accumulators included with this equipment display the chemical symbol Hg, Cd, or Pb, then it means that the battery has a heavy metal content of more than 0.0005% Mercury, or more than 0.002% Cadmium or more than 0.004% Lead.



Note for the battery symbol (bottom symbol):

This symbol might be used in combination with a chemical symbol.

In this case it complies with the requirement set by the Directive for the chemical involved.

Sun light Warning

Avoid using this projector in direct sun light.

Sunlight may cause serious damage to the digital mirror device (DMD™) at the back of the projector lens.

Never look into the projector light source directly

When turn on the projector, make sure nobody's eye will effects by the projection of light.

Always avoid to let eyes contact to the light.

As with any bright source, do not stare into the direct beam, RG2 IEC 62471-5:2015.

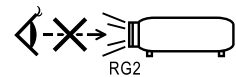

Key any object away from concentrated projection light beam

Blocking the beam by something causes high temperature and could result in fire or smoke.

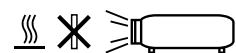

Warning, Notices and Safety Instructions

Electric shock

To protect your projector, avoid turning on the projector during lightning storms and unplug it from the wall outlet. This will prevent sudden electrical surges caused by the lightning from damaging the projector.

Do not overload wall outlets/extension cords

Pay attention to the current load of the outlet and cord you are using to prevent fire or electrical shock.

Cleaning

When cleaning the projector, be sure to unplug it from the wall outlet to prevent electric shock.

Do not use liquid or aerosol cleaners. Use a dry/damp cloth with excessive moisture removed for cleaning. Be sure to use cleaning cloth designed to clean monitors for the projector to prevent damages to the projector casing due to abrasion.

Dampness, smoke, steam, dust, high temperature and direct exposure to sunlight

Do not operate the projector in environments where it could be exposed to dampness, smoke, steam, dust, high temperature or direct sunlight. For example: bathroom, kitchen, adjacent to washing machine, damp basement rooms, electric heaters or similar environments. Keeping or operating the projector in the above-mentioned environment could lead to discoloration, mold formation, grease or damages to the projector.

Do not place the projector where any oils, such as cooking or machine oil, are used. Oil may harm the product, resulting in malfunction, or falling from the mounted position. Do not use adhesive such as threadlocker, lubricant and so on.

Ventilation

The projector case is designed with slots and openings to remove the heat inside the projector so that it will not overheat and damage the components. Be sure to operate the projector in an environment with ideal ventilation and don't operate it on a sofa, rug or other closed-in environments that could obstruct ventilation.

Intrusion of foreign objects

Be sure to keep all foreign objects away from entering the projector because it could be exposed to hazardous voltages and cause parts to short circuit. This could in turn lead to fire hazard or electric shock. Examples of foreign objects include: cockroach, screws, liquid and so forth.

In addition, never spill liquid into the projector.

Carrying the projector

The projector net weight is approximately 11.4 kg . When moving the projector on a cart, be sure to handle the cart with care as abrupt stops, jolts of excessive force or uneven ground could lead the projector to topple.



Please install the projector on an even and stable surface

Avoid placing the projector on unstable cart, tripod, table and so forth to prevent the projector from falling, becoming damaged or causing injuries.

Servicing

Should you encounter problem with the projector, please seek assistance from your local dealer or qualified service personnel. Do not attempt to service the projector by yourself so that you would not be exposed to high voltage or other potential hazards.



No service is allowed except by authorized personnel.

Should you encounter any of the following situation, please unplug your projector from the wall outlet and contact a qualified service personnel for assistance:

- Damaged power cord or power plug.
- If a foreign object has fallen into the projector or if you have spilled water or other liquid into the projector.
- If the projector has been dropped accidentally or damaged.
- If you experience noticeably poor performance or malfunctioning with the projector despite having followed instructions for normal operation.

Changing parts

Should any part of the projector be damaged, check with your servicing personnel that only manufacturer certified parts were used for replacement. Used of non-certified parts may result in damages to the projector or hazards such as fire or electric shock. After changing parts, be sure to remind the servicing personnel to perform safety inspections to ensure that the projector operates normally.



No maintenance allowed by end user, Do not open the cabinet.

No user serviceable part inside.

Warning, Notices and Safety Instructions

Power cord

Don't place the projector where the cord can be walked on. This may result in fraying or damage to the power cord, especially at the plug and the point of connection between the power cord and the projector.













Please use the power cord that comes with the projector or the type of power cord specified for the projector (refer to the descriptions printed on the power cord). If you are not sure of the power available at the region you are in, consult your local power company to prevent damages to the projector due to the use of wrong power cord or potential fire hazards due to current overload.

Depending on the country and region you are in, the voltage and type of socket of the wall outlet may be different from the projector. If you are unable to fit the power plug into the wall outlet, contact your local dealer and do not remove the extra pin on the power plug to forcibly fit it to the socket at the risk of your own safety.

Connect the ground terminal for the AC inlet of this unit to the ground terminal of the building using an appropriate power cord (bundled).

Install the projector where you can access the power outlet easily.

Safety mark

	ENGLISH	FRANÇAIS	DEUTSCH	ESPAÑOL	PORTUGUÊS
	Descriptions of the symbols displayed on the projector	Les descriptions de ces symboles sont affichées sur le projecteur	Beschreibungen der am Projektor angezeigten Symbole	Descripciones de los símbolos mostrados en el proyector	Descrições dos símbolos apresentados no projector
	Alternating Current	Courant Alternatif	Wechselstrom	Corriente alterna	Corrente alternada
	Standby (Power)	Veille (Alimentation)	Bereitschaft (Stromversorgung)	En espera (Alimentación)	Em espera (Alimentação)
	On (Power)	Marche (Alimentation)	Ein (Stromversorgung)	Encendido (Alimentación)	Ligado (Alimentação)
	Off (Power)	Arrêt (Alimentation)	Aus (Stromversorgung)	Apagado (Alimentación)	Desligue (Alimentação)
	WARNING / CAUTION	AVERTISSEMENT / ATTENTION	WARNUNG / VORSICHT	ADVERTENCIA / PRECAUCIÓN	AVISO / PRECAUÇÃO
	HIGH TEMPERATURE	HAUTE TEMPERATURE	HOHE TEMPERATUR	ALTA TEMPERATURA	TEMPERATURA ALTA
					
	HIGH VOLTAGE	HAUTE TENSION	HOCHSPANNUNG	ALTO VOLTAJE	VOLTAGEM ALTA
	HIGH PRESSURE	HAUTE PRESSION	HOCHDRUCK	ALTA PRESIÓN	PRESSÃO ALTA
	PROJECTOR NOT FOR CONSUMER USE	PROJECTEUR DESTINÉ À UN USAGE PROFESSIONNEL	PROJEKTOR NICHT FÜR DEN PRIVATEN GEBRAUCH	PROYECTOR NO DESTINADO A USO POR PARTE DE CONSUMIDORES	PROJECTOR NÃO DESTINADO AO USO DE CONSUMIDORES
	OPTICAL RADIATION WARNING	ATTENTION RAYONNEMENT LASER	WARNUNG! OPTISCHE STRAHLUNG	ADVERTENCIA SOBRE LA RADIACIÓN ÓPTICA	AVISO DE RADIAÇÃO ÓPTICA
	Kensington	Kensington	Kensington	Kensington	Kensington
	MERCURY CONTAINED	CONTIENT DU MERCURE	QUECKSILBERHALTIG	CONTIENE MERCURIO	CONTÉM MERCÚRIO

Warning, Notices and Safety Instructions

ENGLISH	FRANÇAIS	DEUTSCH	ESPAÑOL	PORTUGUÊS
Descriptions of the symbols displayed on the projector	Les descriptions de ces symboles sont affichées sur le projecteur	Beschreibungen der am Projektor angezeigten Symbole	Descripciones de los símbolos mostrados en el proyector	Descrições dos símbolos apresentados no projector
 RG2 caution	ATTENTION: RG2	Achtung! RG2	Precaución sobre RG2	Atenção RG2
 DO NOT LOOK INTO THE BEAM	NE PAS REGARDER DANS LE FAISCEAU	NICHT IN DEN STRAHL BLICKEN	NO MIRE AL HAZ	NÃO OLHE PARA O FEIXE
 DO NOT SHADE THE LIGHT	NE PAS COUVRIR LA LUMIÈRE	LICHTWEG NICHT BLOCKIEREN	NO TAPE LA LUZ	NÃO BLOQUEIE A LUZ
 Laser Warning	Avertissement Relatif au Laser	Warnhinweis zum Laser	Advertencia Relacionada con el Láser	Aviso Relativo ao Laser
中文	한국어	РУССКИЙ	日本語	
投影机上显示的标志符号说明	프로젝터에 표시되어 있는 기호에 대한 설명	Описания символов, отображаемых на проекторе	機器上に表示しているシンボル説明	
 交流电	교류 전류	Переменный ток	交流電流	
 待机 (电源)	스탠바이(전원)	Ожидание (питание)	スタンバイ (電源)	
 开启 (电源)	온(전원)	Включено (питание)	オン(電源)	
 关闭 (电源)	끄기(전원)	выключено (питание)	オフ (電源)	
 警告 / 注意事项	경고 / 주의	ПРЕДУПРЕЖДЕНИЕ / ВНИМАНИЕ	注意 / 警告	
 小心高温	고온 주의	ВЫСОКАЯ ТЕМПЕРАТУРА	高温注意	
 HOT				
 小心触电	감전 주의	ВЫСОКОЕ НАПРЯЖЕНИЕ	感電注意	
 小心破裂	파열 주의	ВЫСОКОЕ ДАВЛЕНИЕ	破裂注意	
 该投影机非普通消费者使用	비소비자용 프로젝터	ПРОЕКТОР НЕ ПРЕДНАЗНАЧЕН ДЛЯ ПОТРЕБИТЕЛЬСКОГО ИСПОЛЬЗОВАНИЯ	民生用では無い機器	
 光辐射警告	광 방사 경고	ПРЕДУПРЕЖДЕНИЕ ОБ ОПТИЧЕСКОМ ИЗЛУЧЕНИИ	光放射警告	
 Kensington	Kensington	Kensington	Kensington	
 含水银	수은 함유	РТУСОДЕРЖАЩИЙ	水銀含有	
 小心RG2	RG2 주의	Внимание RG2	RG2 注意 (覗き込み禁止)	
 禁止直视光束	빔을 들여다 보지 마십시오	НЕ СМОТРИТЕ НА ЛУЧ	覗き込み禁止	
 小心不要遮挡投影机发出的光	램프를 가리지 마십시오	НЕ ЗАТЕНЯЙТЕ СВЕТ	光を遮るな注意	
 激光警告	레이저 경고	Предупреждение о Лазерном Излучении	レーザーに関する警告	

Warning, Notices and Safety Instructions

Notices you should read prior to the installation of the projector

Take frequent breaks to let your eyes rest

Prolonged viewing of the projector screen could strain your eyes. Please be sure to rest your eyes adequately.

Installation environment for the projector

You should avoid installing the projector at place of excessive dampness, dust or smoke. If installation in such environment is unavoidable, be sure to have the interior of the projector.

Cleaned routinely to prolong the projector's lifecycle. Cleaning of the projector's interior should only be performed by qualified service personnel dispatched by your local dealer and you should not attempt to clean the inside of the projector by yourself.

If other light source is directly projected onto the projector screen, the color of the picture from the projector will appear to be pale and the picture quality will be lower. In addition, your eyes would be more prone to fatigue. Therefore, it is recommended that the projector be installed in places without direct exposure to sunlight or other sources of intense light.

The ideal operating temperature range for the projector is between 0°C ~ 40°C (32°F ~ 104°F)

The ideal storage temperature range for the projector is between -20°C ~ 60°C (4°F ~ 140°F)

Configurations for projector operation at high altitudes

When operating the projector at higher altitudes, be sure to manually set the fan mode to "High" or it could shorten the life of the optical system in the projector. High altitude is defined as places being 1520 meters (5000 feet) or higher.

Please refer to Page 62 and Page 76.

Protect the projector with care

When placing the projector at a high position, be sure to secure the projector firmly so that it would not fall and cause injuries. Take care to protect the projector's lens from collision, abrasion or other damages. Be sure to close the lens cover or cover the projector with a dust cover if you need to store the projector or if it will not be used for an extended time.

Keep the projector's ventilation inlets and outlets free from obstructions

Note the direction of air flow at the designated spot of installation. Do not let the hot air released from the outlet flow back to the inlet as it will prevent proper cooling and lead to damage of the projector's internal structure.

In the event of high temperature due to malfunctioning of the internal cooling fan caused by clogging at the ventilation inlets and outlets, the projector will activate its automatic protection mode and shutdown. When this happens, it does not necessary mean that the equipment is malfunctioning. Try to unplug the power cord from the wall outlet and wait for approximately 15 minutes before operating the projector again (remember to remove the objects that have caused poor ventilation so that the projector will not go into the protection mode again).

Warning, Notices and Safety Instructions

Description: The regulation of temperature inside the projector by the cooling fan is automatic. And as such, the sound of cooling fan changing its operating speed does not imply that a problem has occurred with the projector.

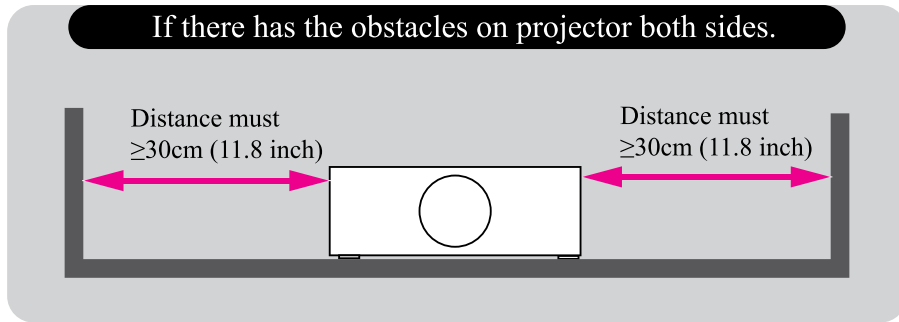

Positioning precautions

This projector can be installed 360° range. But life of optical parts will be shorten as portrait situation:

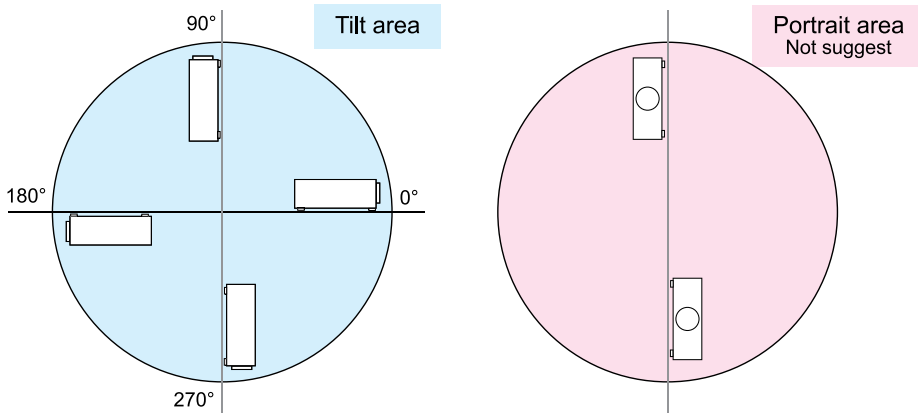

Warning, Notices and Safety Instructions

Caution for 3D

- Don't let children view the 3D by themselves , please always be accompanied by an adult.
- Although more than six years old can view the 3D. But children may not tell you if they are feeling unwell when viewing 3D content, so always be sure to check with the child.
- When viewing 3D content, be sure you are at an appropriate distance from the front of the screen. Suggest keep at least three times the height of the screen away from the screen.
- Check that the settings are correct and that the 3D effect is being correctly applied. If the image is inversed and the left and right eye images are swapped, the 3D effect does not work, which could cause eye strain or cause you to feel unwell.

3D content not suitable for below situation, it could aggravate their pre-existing conditions.

- People with a history of photosensitive epilepsy.
- People has heart disease.
- Pregnant women.
- People with serious illnesses.
- People with a history of epileptic seizures.

Suggest stop to view the 3D, if has below situation:

- When you feel unwell , tired, sleep deprived, fatigued or inebriated.
- The 3D image doubled or not clear.
- Enjoying 3D content that rotates, rolls, or shakes, some person may feel they are moving and trigger a form of “sea sickness”.
- Take too long time for viewing 3D content, be sure to take regular breaks to avoid cause eyestrain.

LASER WARNING



This symbol indicates that there is a potential hazard of eye exposure to laser radiation unless the instructions are closely followed.

CLASS 3R LASER PRODUCT



This Laser Product is designated as Class 3R during all procedures of operation.

LASER LIGHT - AVOID DIRECT EYE EXPOSURE.

Do not point laser or allow laser light to be directed or reflected toward other people or reflective objects.

Direct or scattered light can be hazardous to eyes and skin.

There is a potential hazard of eye exposure to laser radiation if the included instructions are not followed.

Caution – use of controls or adjustments or performance of procedures other than those specified herein may result in hazardous radiation exposure.

Laser parameters

Wavelength	450nm - 460nm (Blue)
Mode of operation	Pulsed, due to frame rate
Pulse width	1.34ms
Pulse repetition rate	120Hz
Maximum laser energy	0.698mJ
Total internal power	>100W
Apparent source size	>10mm, at lens stop
Divergence	>100 mili Radian

Warning, Notices and Safety Instructions

Product labels

Below drawing show the label's location.

1 Manufacturer's ID

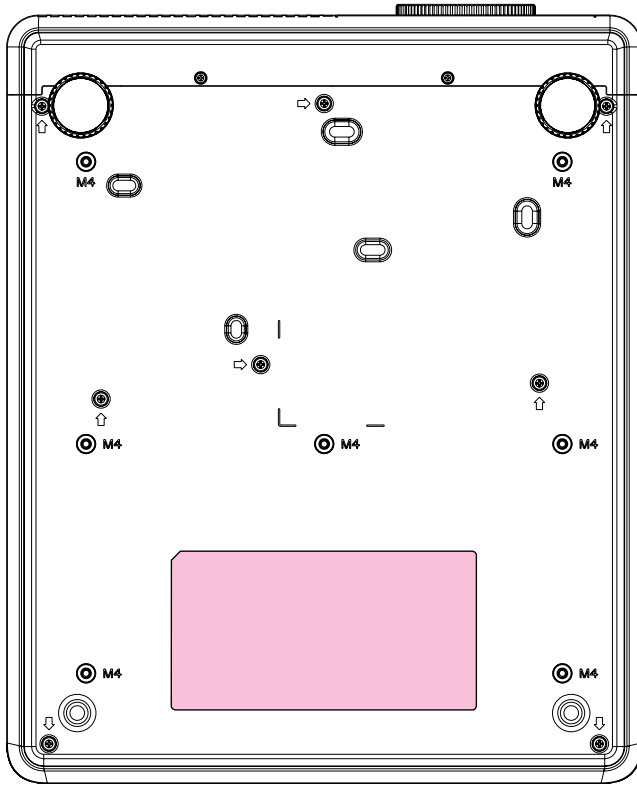

2 Serial No. MAC Label

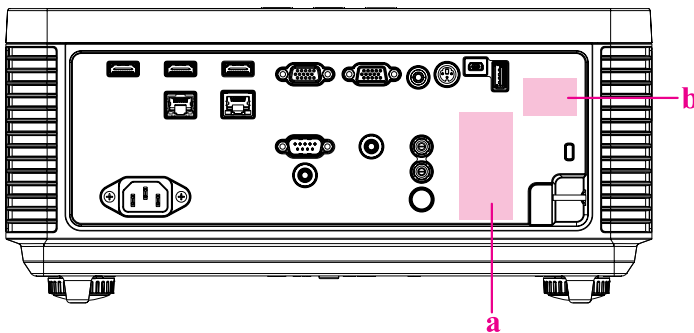

- a. Serial No.
- b. MAC Label

3 Hazard Warning Symbol, Aperture Label, Certification Statement Label and Explanatory Label

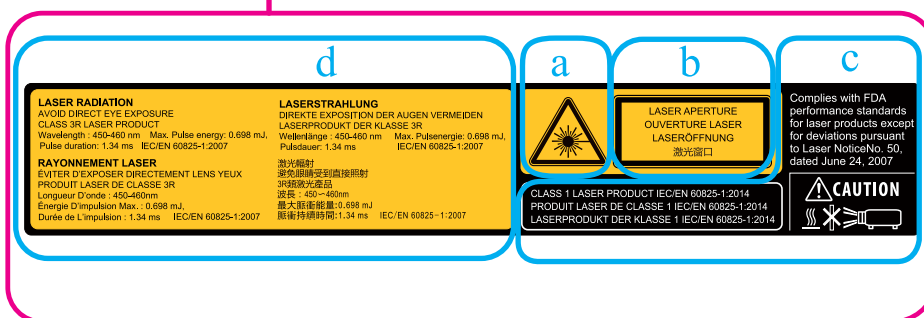
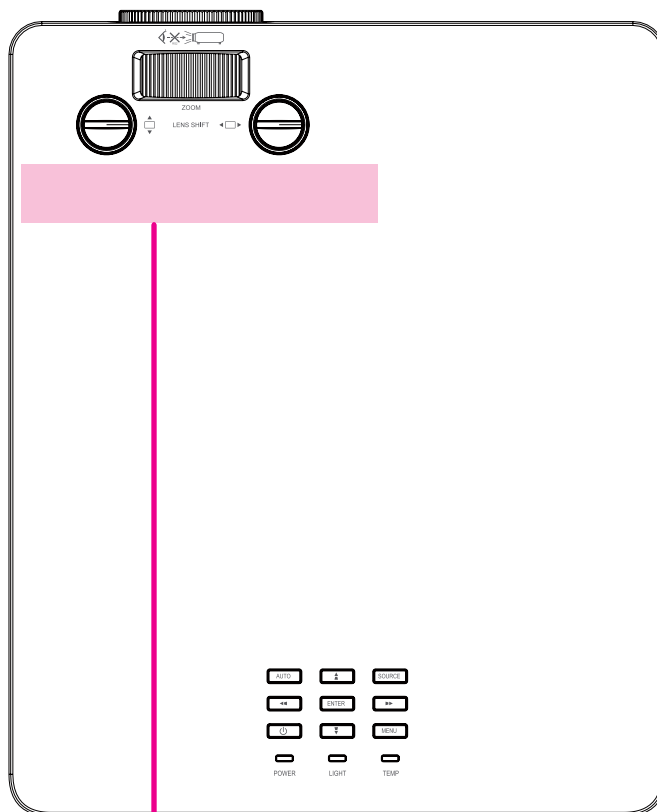

Warning, Notices and Safety Instructions

- a. Hazard Warning Symbol
- b. Aperture Label
- c. Certification Statement Label
- d. Explanatory Label

Warning, Notices and Safety Instructions

Location of laser aperture

Following drawing shows the laser aperture location. Be careful not to see the light directly.

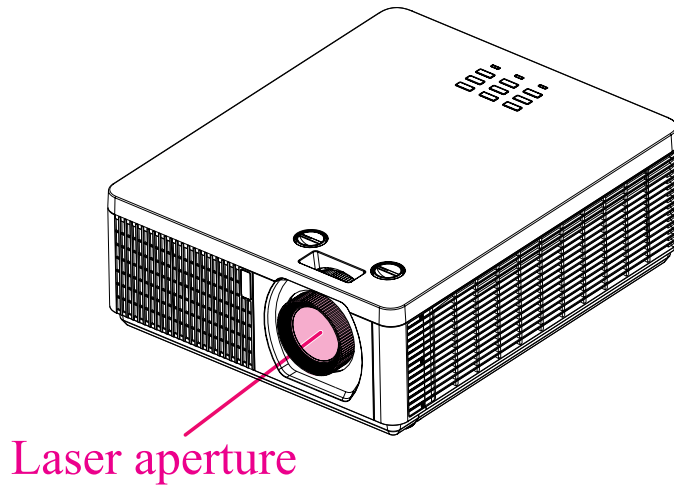

Interlock switches

This machine has interlock switches to protect the laser light leakage.

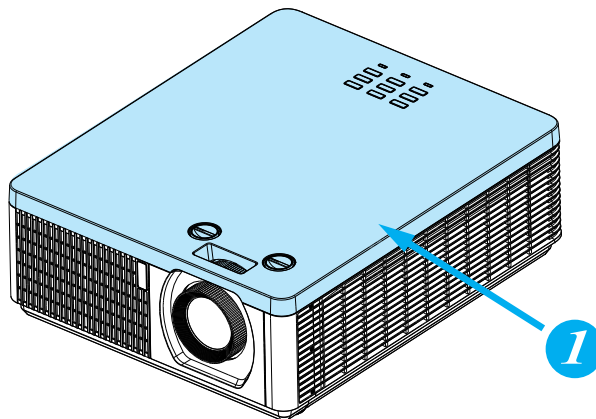

1 Switch will power-off the system when the Top cover is opened.

Note: The Dukane model described in this document is manufactured by Hitachi and uses the same firmware, software programs, control code, and accessory parts. The equivalent Dukane to Hitachi models is 8965WUSS (LP-WU6500).

Projector parts and functions

Front view

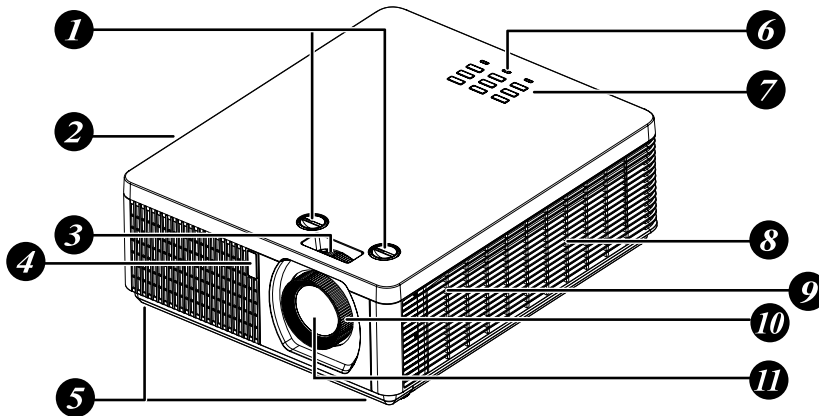

- | | |
|---|---|
| <ol style="list-style-type: none"> 1. LENS SHIFT
Adjust the projected image position. 2. Ventilation outlet
The hot air generated inside the projector is dispersed through the ventilation slot. Make sure the ventilation slot is free from obstruction. 3. Zoom
Zoom in or zoom out the projected image 4. Infrared receiver 5. Adjustable foot
Adjust the height and angle of the projector with the adjustable foot. | <ol style="list-style-type: none"> 6. LED Indicator 7. Projector keypad 8. Ventilation inlet
The internal cooling fan draws cool air from the ventilation inlet into the projector. 9. Speaker 10. Focus
Adjust the projected image's focus. 11. Lens |
|---|---|

LED Indicator

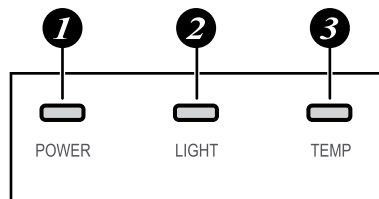

- | | |
|---|---|
| <ol style="list-style-type: none"> 1. POWER
The indicator shows the power status. The indicator lights when the projector is in standby state. The indicator blinks once every 5 seconds when the projector is an ON state. | <ol style="list-style-type: none"> 2. LIGHT
The indicator shows the light source and system error status. 3. TEMP.
The indicator shows the thermal error message. |
|---|---|

Projector parts and functions

Rear view

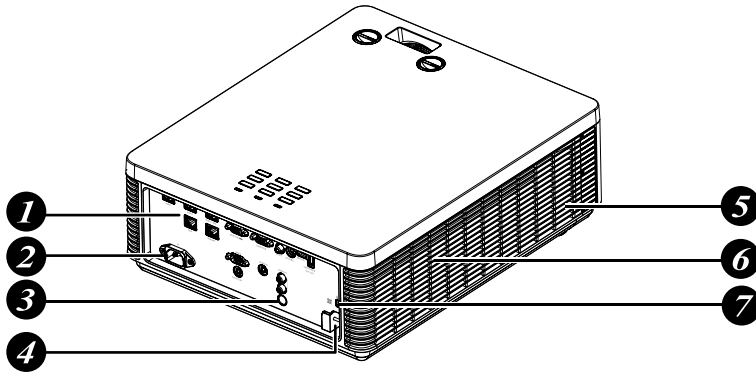

- 1. I/O port
- 2. Power inlet
- 3. Infrared sensor
- 4. Security bar

- 5. Speaker
- 6. Ventilation outlet
- 7. Kensington® lock

Projector keypad

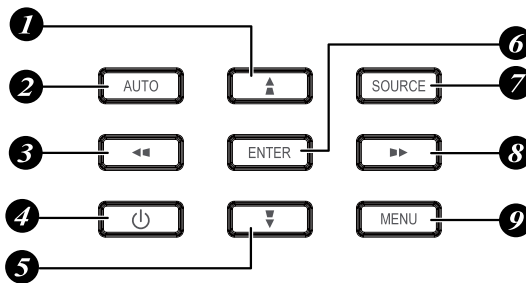

- 1. ▲ / ▼
Use this button to make your selection or configure, adjust configuration on the menu.
Keystone can be adjusted when no other menu is displayed.
- 2. **AUTO**
Auto adjust the signal synchronization.
- 3. ◀ / ▶
Use this button to make your selection or configure, adjust configuration on the menu.
Keystone can be adjusted when no other menu is displayed.
- 4. ⏻
Press to turn on or off the projector.
- 5. ▼ / ▲
Use this button to make your selection or configure, adjust configuration on the menu.
Keystone can be adjusted when no other menu is displayed.

- 6. **ENTER**
Press to select items in the menu or confirm the settings you have changed.
- 7. **SOURCE**
Select input signal source.
- 8. ▶ / ◀
Use this button to make your selection or configure, adjust configuration on the menu.
Keystone can be adjusted when no other menu is displayed.
- 9. **MENU**
Displays or hides the menu.

I/O Port (Input / Output)

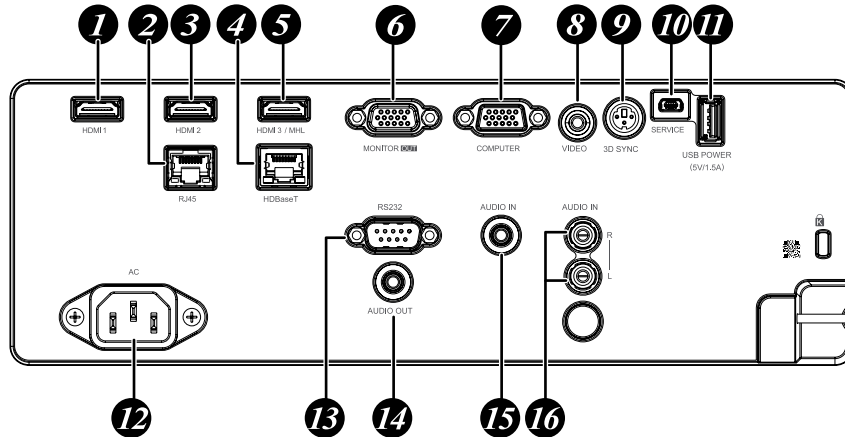

1. **HDMI 1** (Digital audio/video connector)
Connect to HDMI or DVI source.
2. **RJ45**
Connect a LAN cable from Ethernet.
3. **HDMI 2** (Digital audio/video connector)
Connect to HDMI or DVI source.
4. **HDBaseT** (RJ-45 jack)
Connect to HDBaseT source via LAN cable.
5. **HDMI 3 / MHL** (Digital audio/video connector)
Connect to a HDMI or MHL-compatible device.
6. **MONITOR OUT** (D-sub 15-pin mini shrink jack)
Connect to a monitor.
Loop through only for COMPUTER.
7. **COMPUTER** (D-sub 15-pin mini shrink jack)
Connect to a PC.(Support RGB and component video signal input).
8. **VIDEO** (RCA jack)
Connect to the composite video device.
9. **3D SYNC** (VESA 3-pin)
Connect to 3D IR glasses receiver unit.
10. **SERVICE**
For service personnel only.
11. **USB POWER** (USB A type jack)
Connect a USB device. (Support 5V/1.5A output while the projector Power On.)
12. **AC**
Connect a POWER cable.
13. **RS-232C** (9-pin D-sub socket) (Cross cable)
Connect your PC or system control equipment.
14. **AUDIO OUT** (3.5 mm, mini jack)
Connector to an audio amplifier device.
15. **AUDIO IN** (3.5 mm, mini jack)
Connect an audio source input. (Available for Computer, BNC, DVI-D source.)
16. **AUDIO IN (L/R)** (RCA jack)
Connect an audio source. (Available for Video signal input.)

Projector parts and functions

Bottom view

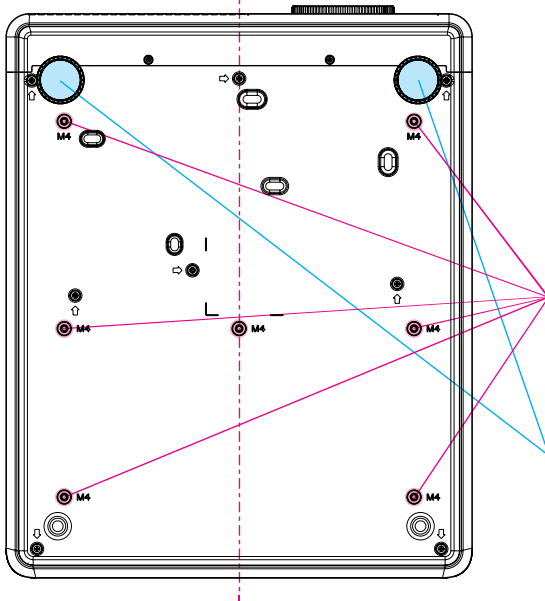
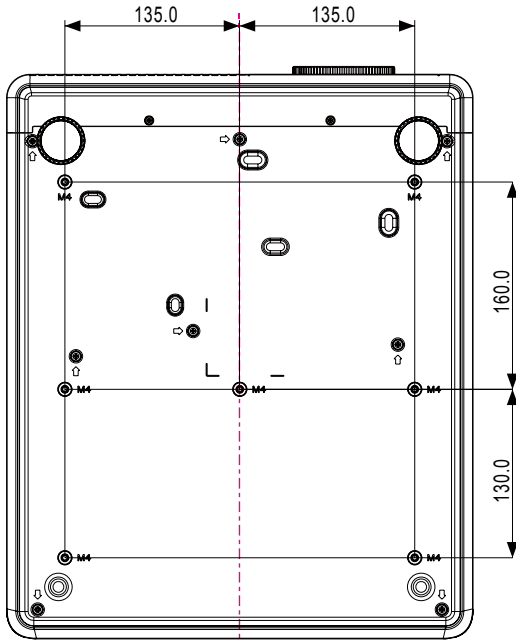

Mounting bracket screw hole

These screw holes are used to mount the projector to its designated mounting bracket using 6 M4x12L screws. The dimensions of the screw holes are shown in the picture below.

Adjustable foot

Adjust the height and angle of the projector with the adjustable foot.

Remote control

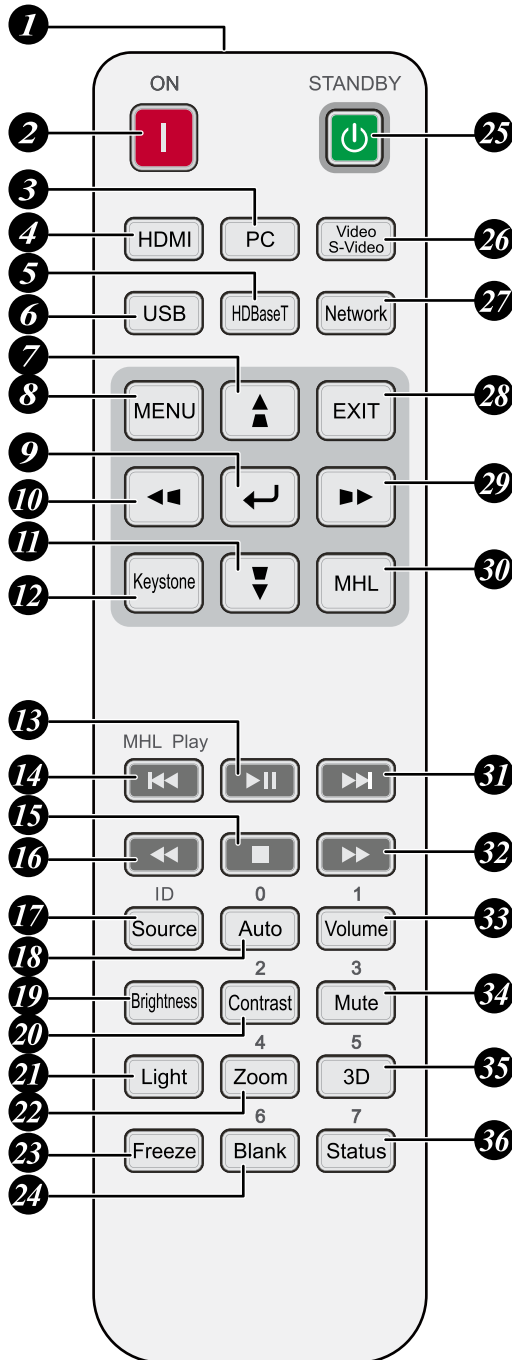

1. **IR transmitter**
2. **ON**
This button is used to turn on the projector.
3. **PC**
Displays the VGA (COMPTER IN) / BNC (R/B/G/H/V) source selection (toggle).
4. **HDMI**
Displays the HDMI 1/HDMI 2/DVI source selection (toggle).
5. **HDBaseT**
Displays the HDBaseT source selection.
6. **USB**
Not available for this projector.
7. **▲ / ▼**
Use this button to make your selection or configure, adjust configuration on the menu.
Keystone can be adjusted when no other menu is displayed.
8. **MENU**
Displays or hides the menu.
9. **↵ (ENTER)**
Press to select items in the menu or confirm the settings you have changed.
10. **◀ / ▶**
Use this button to make your selection or configure, adjust configuration on the menu.
Keystone can be adjusted when no other menu is displayed.
11. **▼ / ▲**
Use this button to make your selection or configure, adjust configuration on the menu.
Keystone can be adjusted when no other menu is displayed.
12. **Keystone**
Press to open keystone adjustment menu.
13. **▶||**
Play or pause video/music for MHL.
14. **◀◀**
Play the previous item on the programming list for MHL.
15. **■**
Stop video/music playing for MHL.
16. **◀◀**
Reverse in set increments for MHL.
17. **Source**
18. **Auto**
19. **Brightness**
20. **Contrast**
21. **Light**
22. **Zoom**
23. **Freeze**
24. **Blank**
25. **STANDBY**
26. **Video S-Video**
27. **Network**
28. **EXIT**
29. **▶▶**
30. **MHL**
31. **▶▶**
32. **▶▶**
33. **Volume**
34. **Mute**
35. **3D**
36. **Status**

Remote control

17. **Source**
Select input source.
Combo key function for Remote Control ID settings (Press ID button + Number for 3 seconds).
18. **Auto / 0**
This button is used to Resync the picture; when the picture signal becomes unstable or picture quality deteriorates simply press this button and the projector will automatically adjust the screen dimension, phase, timing and so forth.
Number for Remote ID setting used.
19. **Brightness**
Displays the brightness setting bar.
20. **Contrast / 2**
Displays the Contrast settings bar.
Number for Remote ID setting used.
21. **Light**
Displays the light power adjustment menu.
22. **Zoom / 4**
Displays the digital zoom settings bar.
Number for Remote ID setting used.
23. **Freeze**
Freeze/unfreeze the picture on the screen.
24. **Blank / 6**
Makes the screen blank.
Number for Remote ID setting used.
25. **STANDBY**
This button is used to turn off the projector.
26. **Video / S-Video**
Displays the Video source selection.
27. **Network**
Open the Network menu.
28. **EXIT**
Press this button to exit menu or return to previous menu level.
29. **▶ / ▀**
Use this button to make your selection or configure, adjust configuration on the menu.
Keystone can be adjusted when no other menu is displayed.
30. **MHL**
Change MHL / Projector mode.
31. **▶▶**
Play the following item on the programming list for MHL.
32. **▶▶**
Forward in set increments for MHL.
33. **Volume / 1**
Displays the Volume setting bar.
Number for Remote ID setting used.
34. **Mute / 3**
Mutes the built-in speaker.
Number for Remote ID setting used.
35. **3D / 5**
Open the 3D Setting menu.
Number for Remote ID setting used.
36. **Status / 7**
Opens the Status menu (the menu only opens when an input device is detected).
Number for Remote ID setting used.
Note:
Remote Combo Key Settings:
ID+0: Reset Remote Control ID to default settings.
ID+1: Set Remote Control ID to "1".
~
ID+7: Set Remote Control ID to "7".
Projector also need setting ID for unique control. Refer to Page 62 : "Remote ID".
Note: When the projector is under MHL mode, the keypad on projector should be same definition of the key on remote control.
With MHL function:
MENU for App settings, ▲ Up, ▼ Down, ◀ Left and ▶ Right are used as directional arrows, also included ENTER and EXIT.
Controlling your smart device with the remote control:
When the projector displays the content from your MHL compatible smart device, you can use the remote control to control your smart device. To enter the MHL mode, the following buttons are available for controlling your smart device, Arrow keys (▲ Up, ▼ Down, ◀ Left, ▶ Right), MENU, EXIT, MHL control buttons.

Range of effective remote control signal reception

The diagram below illustrates the range of effective remote control signal reception (Unused new battery).

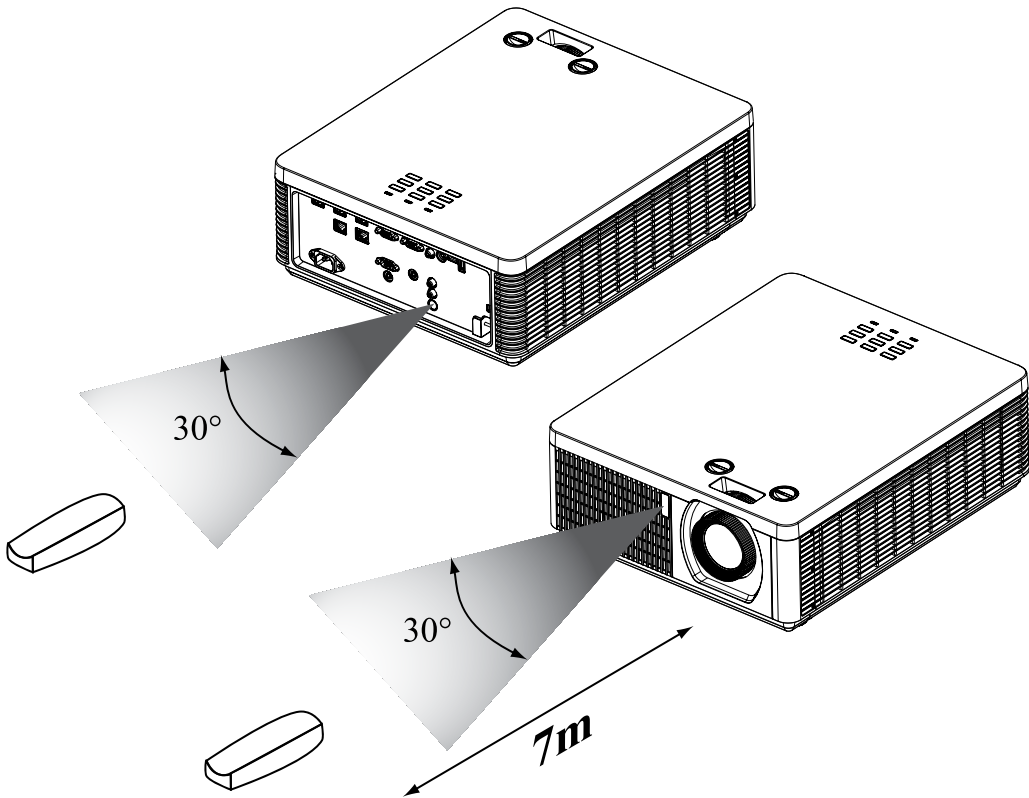

Note: Avoid placing the remote control at places of high temperature or humidity as it could cause the remote control to malfunction.

Note: If the infrared receiver is exposed to fluorescent lamp or strong sunlight, the remote control may not operate normally.

Installing batteries in the remote control

1. Remove the cover by sliding it in the direction indicated by the arrow.
2. Insert two new AAA batteries (check the polarity).
3. Replace the cover.

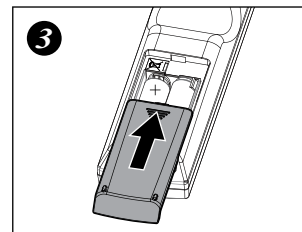
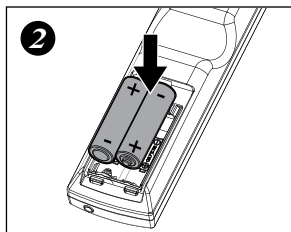
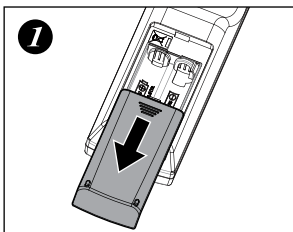

Note: Always handle the batteries with care and use them only as directed. Improper use may result in battery explosion, cracking or leakage, which could result in fire, injury and/or pollution of the surrounding.

Note: Keep a battery away from children and pets.

Remote control

Note: Do not recharge, short circuit, solder or disassemble a battery.

Note: Be sure to insert the batteries in the corresponding orientations to match the polarities.

Note: Do not mix new battery with used one as it would shorten the life of new one or cause leakage.

Note: Use AAA batteries as instructed; do not attempt to insert different types of batteries into the remote control.

Note: If you will not use the remote control for long period, remove the batteries from the remote control and store them in a safe place.

Note: The liquid contents in the batteries is harmful to the skin; do not touch the leakage with your bare hands directly. When installing fresh batteries, be sure to clean up the leakage thoroughly.

Note: If the range of effective remote control signal reception decreases or if the remote control stops working, replace the batteries.

Note: Refer to the regulations enforced by your local government on the disposal of used batteries; improper disposal could damage the environment.

Caution: RISK OF THE EXPLOSION IF BATTERY IS REPLACED BY ANY INCORRECT TYPE.

Caution: DISPOSE OF USED BATTERIES ACCORDING TO THE INSTRUCTIONS.

Projector installation

Throw distance

Throw Distance (TD) = Screen Width (W) x Throw Ratio (TR)

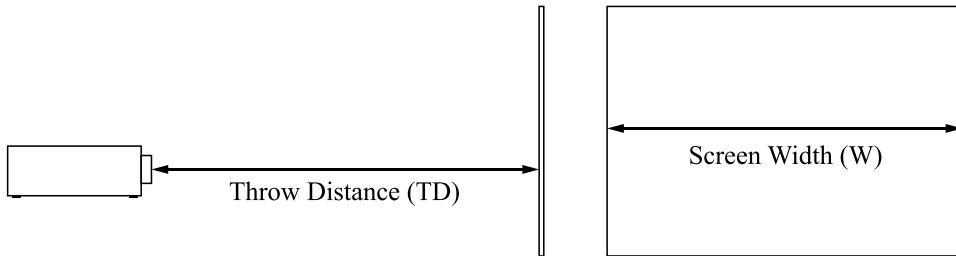

Projector offers the following throw ratios:

- 1.15~1.9 : 1, 36.7~201.9inch

Modes of installation

- Install the projector in an environment from 0°C (32°F) to 40°C (104°F). The projector should be kept away from sources of heat and / or ventilation openings of air conditioner.
Note: The temperature also depends on altitude. Please refer to Page 62 and Page 76.
- The projector should be kept away from devices that emit electromagnetic energy, such as motors or transformers. Common devices that emit electromagnetic energy include slideshow system, speakers, power amplifiers and elevators.
- If you choose to install the projector from the ceiling, be sure to use the ceiling installation components verified safety. For details, please contact your local dealer.

Projection

Normal **P**

Advantages: easy to install can be easily moved or adjusted easy to operate.

Disadvantage: occupies floor space and limits seating capacity.

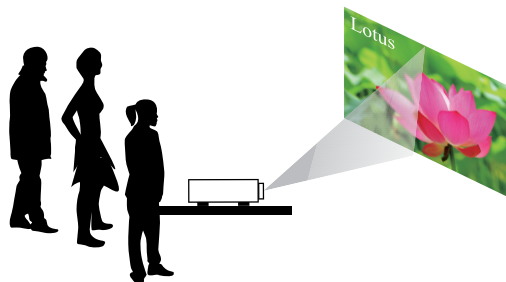

Projector installation

Ceiling

Refer to Page 42 : “Ceiling”

Advantage: does not occupy floor space does not draw attention to it.

Eliminates the possibility that someone would accidentally move the projector.

Disadvantage: stricter installation requirements and conditions; care should be taken during the installation to ensure the projector has been securely mounted. Operation of the projector becomes inconvenient without the remote control.

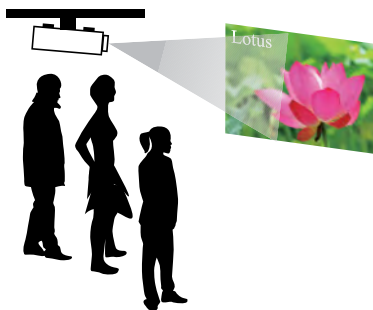

Rear

Refer to Page 42 : “Rear”

Advantage: the projector is completely hidden from plain view the projector can be easily operated this setup usually offers better reduction of ambient noise.

Disadvantage: requires an additional room for installation relatively higher costs for installation.

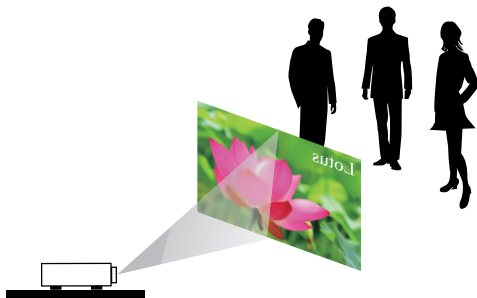

Rear + Ceiling

Refer to Page 43 : “Rear + Ceiling”

Advantage: the projector is completely hidden from plain view this setup usually offers better reduction of ambient noise.

Disadvantage: requires an additional room for installation. Stricter installation requirements and conditions; care should be taken during the installation to ensure the projector has been securely mounted. Operation of the projector becomes inconvenient without the remote control.

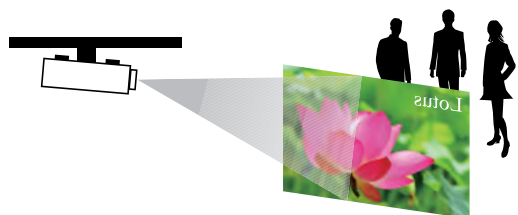

Rear with a Mirror

If you wish to have a rear projection setup with limited space to the rear of the projector, you can use a mirror to reflect the light path.

However, both the projector and the mirror have to be precisely located. If you are considering such installation, please contact your dealer for assistance.

Advantage: the projector is completely hidden from plain view this setup usually offers better reduction of ambient noise.

Disadvantage: requires an additional room for installation relatively higher costs for installation.

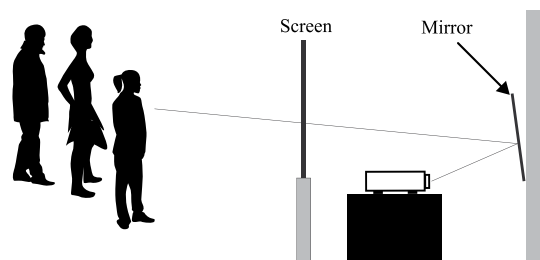

Horizontal and vertical lens shift

In addition to using the adjustable feet to adjust projection angle, you can also use the Lens Shift function to adjust the projected picture.

Lens shift

1. Turn the **VERTICAL** adjuster fully counter clockwise. Then turn it clockwise and adjust the vertical lens position upward.
2. Turn the **HORIZONTAL** adjuster clockwise or counter clockwise to adjust the horizontal lens position.

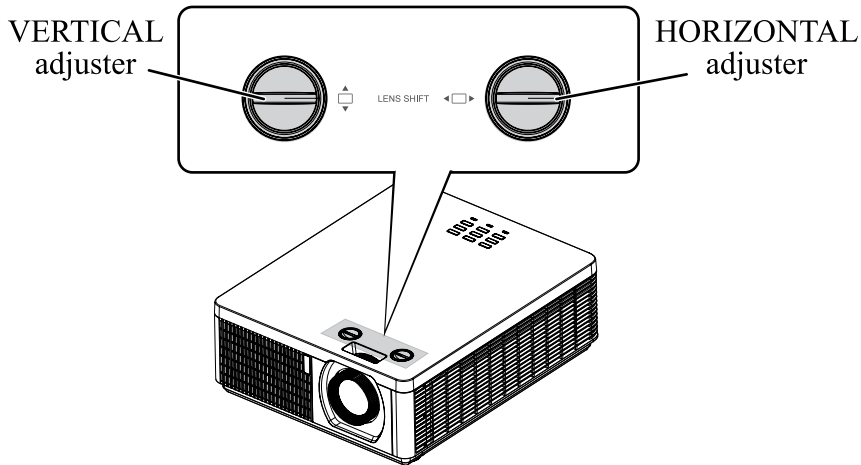

Note for adjusting the lens shift

1. Adjust the lens shift / zoom / focus after 30 minutes since the projector was turned on.
2. Slight changes of the image position and/or focus may occur within 30 minutes after the projector was turned on. If the room temperature and humidity have changed after adjusting the lens shift / zoom / focus, readjust them as necessary.
3. Set the image size including the margin from the screen edge in anticipation of the changes after installation.
4. When adjusting the lens shift vertically, finish adjusting lens shift by moving the projected screen upward. If you finish adjusting the lens shift by moving the projected screen downward, the projected screen may be misaligned slightly downward over time.

Projector installation

Note for adjusting the lens shift

1. You can feel the rotational resistance of the lens adjuster increasing if the lens shift exceed its range. Do not turn the lens adjuster further. If the lens adjuster is turned excessively, it runs idle by a clutch mechanism inside the adjuster. Although it makes a clicking sound, it is not a malfunction. Turn the lens adjuster to the opposite direction to adjust the lens shift.
2. Keep turning the lens adjuster while pressing it downward if the adjuster is turned to the opposite direction with a clicking sound and the lens shift does not work after the adjuster has been turned exceeding the lens shift range. You need to turn the lens adjuster for a while until the lens shift starts.
3. Do not turn the lens adjuster while pressing it downward out of the lens shift range. The lens shift may be locked because a clutch mechanism does not work. In such a case, keep turning the lens adjuster while pressing it downward like in step2.
4. When adjusting the lens shift to the maximal oblique direction, the periphery of the projected screen may be dark or a shadow may be cast.

Caution: Operate the lens adjusters gently as the lens may malfunction when subjected to shocks.

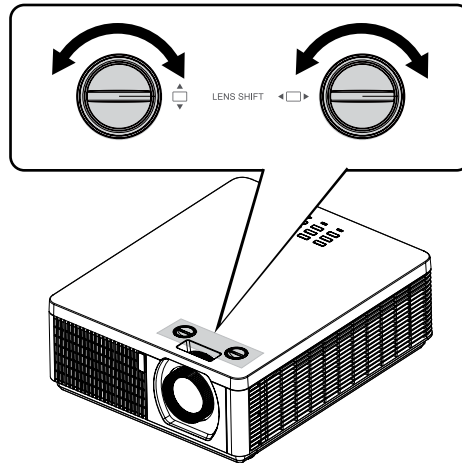

Moving the lens vertically

The distance of vertical lens movement is 12% of the screen height directions (The offset range is about 63% to 75%). For instance, if you are using a 2.15m × 1.35m (100") screen, you will be able to move the picture upwards no more than 13.5cm(10%) and downwards no more than 2.7cm(2%) from default position. (Please confirm the default position in Page 97).

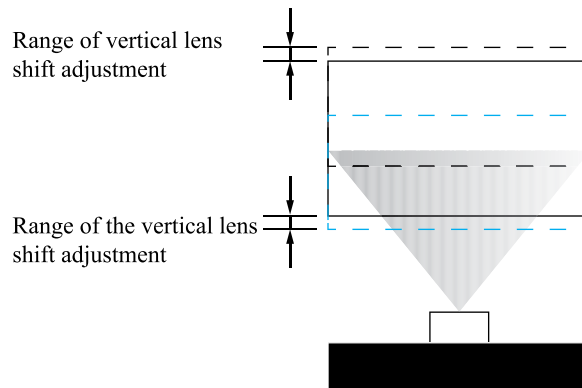

This illustration shows normal vertical lens shift without the use of special specification lens or projector.

Note: Please make sure the center of lens is rectangular to the center of the screen.

Moving the lens horizontally

The distance of horizontal lens movement is 2.5% of the screen width in both directions. For instance, if you are using a 2.15m × 1.35m (100") screen, you will be able to move the picture left or right by no more than 5.4cm.

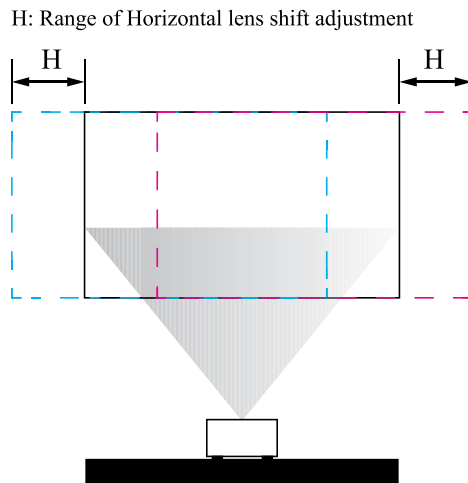

This illustration shows normal horizontal lens shift without the use of special specification lens or projector.

Note: Please make sure the center of lens is rectangular to the center of the screen.

Note: Although the lens shift position can be moved beyond the specification, please use it in the position within the specification. When used at a position outside specifications, the corner of the screen becomes shade or color unevenness becomes large, and sufficient optical performance can not be obtained.

Projector installation

Connecting the projector

HDMI / MHL / DVI connection

Signals from picture source offer the best projection picture quality when sent through HDMI/DVI. Therefore, try to use input devices with HDMI/DVI output as the source of picture.

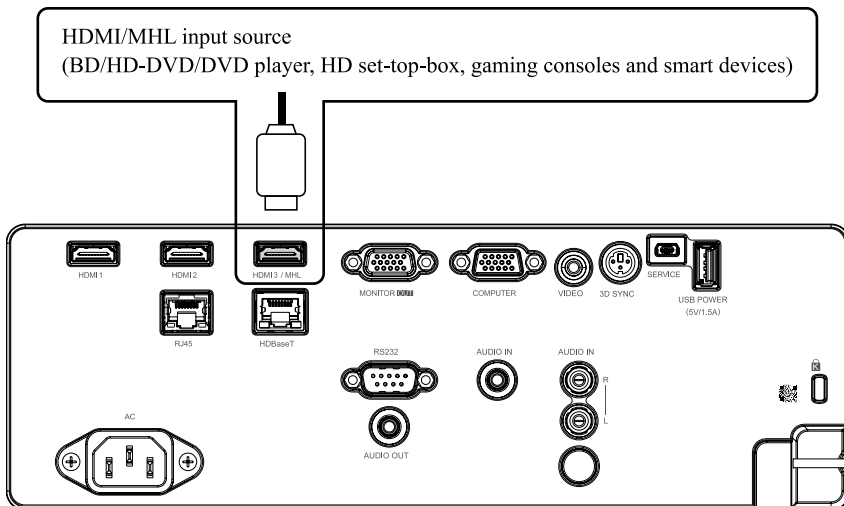
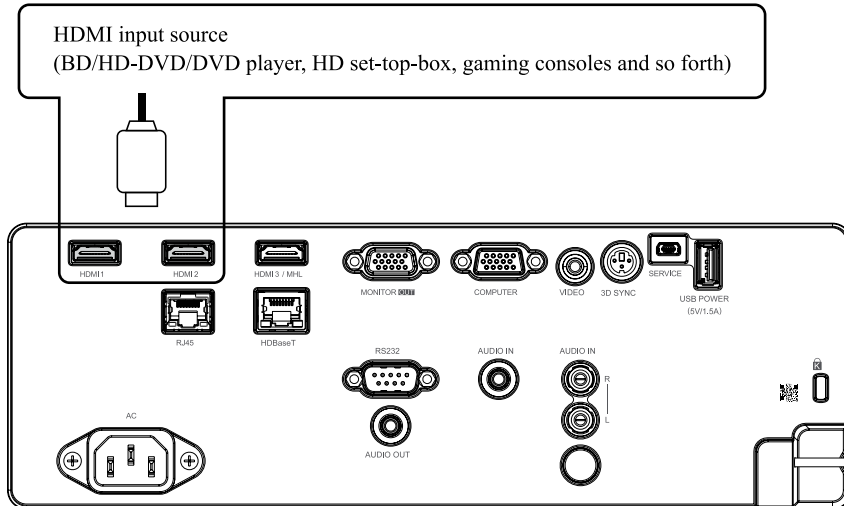

RGB connection

Connect your PC or other devices with RGB output to the RGB input connectors (COMPUTER (in OSD we say VGA)) on the projector to be used as the source of picture input.

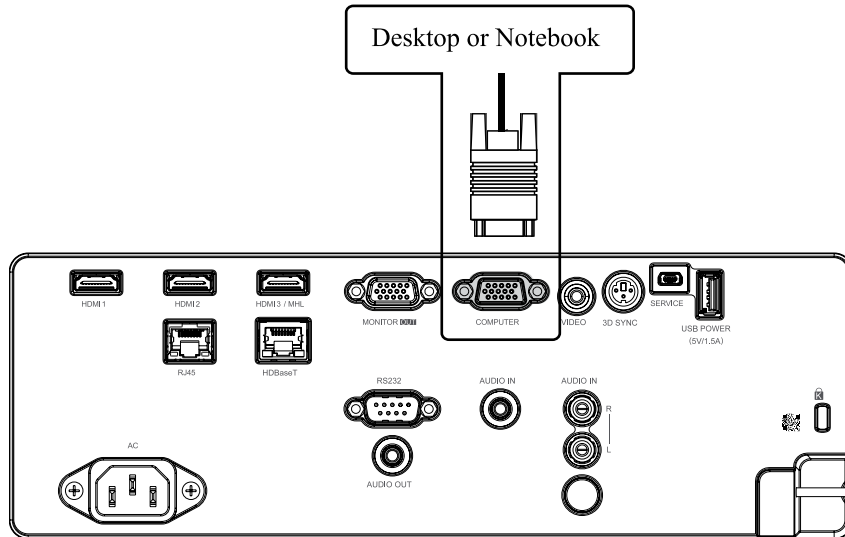

Connect a monitor to MONITOR OUT for through COMPUTER signal.

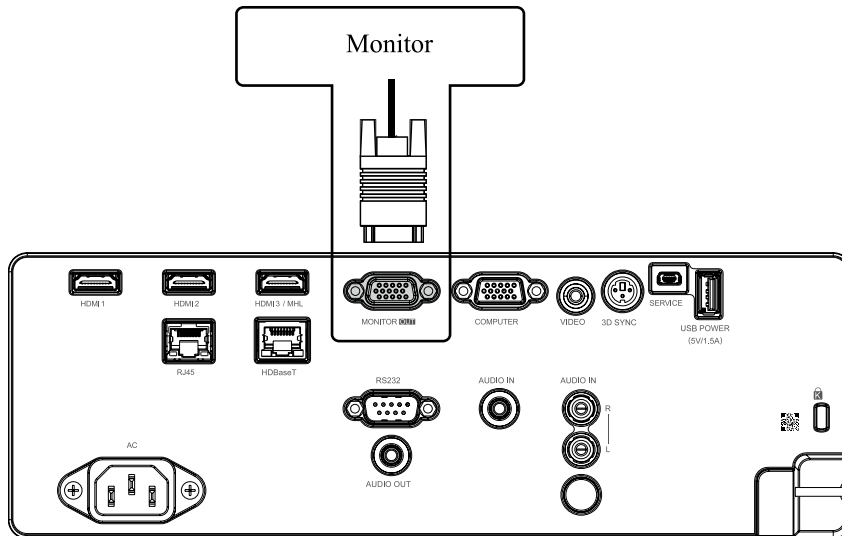

Projector installation

HDBaseT connection

HDBaseT is a technology to transmit image signal use LAN function, RS-232 function and IR function through a LAN cable.

Connect Cat5e/Cat6 cable from HDBaseT TX Box for HDBaseT signal received.

Video Signal - Connect it to HDBaseT output equipment (Such as high-definition TV source, Blu-ray Player....etc).

LAN Function - Key in the correct IP Address or the computer host name which is the same as the projector's host name, then you can remote control the projector by internet.

RS-232 Function: When the projector connects to HDBaseT by RS-232 communication, the projector can be controlled with RS-232 commands from the computer. For details of RS-232 commands, refer to RS-232 Communication command table.

Please turn On the “HDBase-T-IR/RS232/RJ45” in the OSD menu when using LAN function / RS232 function.

Note: RJ45 port and RS-232C port are disabled when “HDBaseT-IR/RS-232/RJ45” is turned On.

Use LAN cables of up to 100m long. Exceeding this length, the image will be deteriorated, and can experience malfunction on LAN transmission.

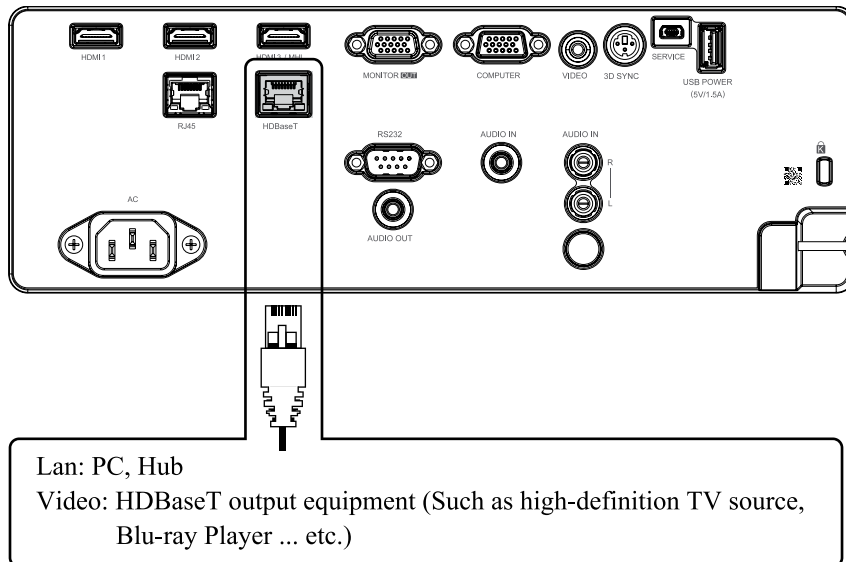

Note: HDBaseT BEST PRACTICE:

- 1. When In Doubt, Use Shielded Cat6 With Shielded Plugs.*
- 2. Use Proper Grounding.*
- 3. Isolate HDBaseT Cat Cables from Other Signal Types.*

RJ45 connection

Connect it to your computer or Hub. Key in the correct IP Address or the computer host name which is the same as the projector's host name then you can remote control the projector by internet.

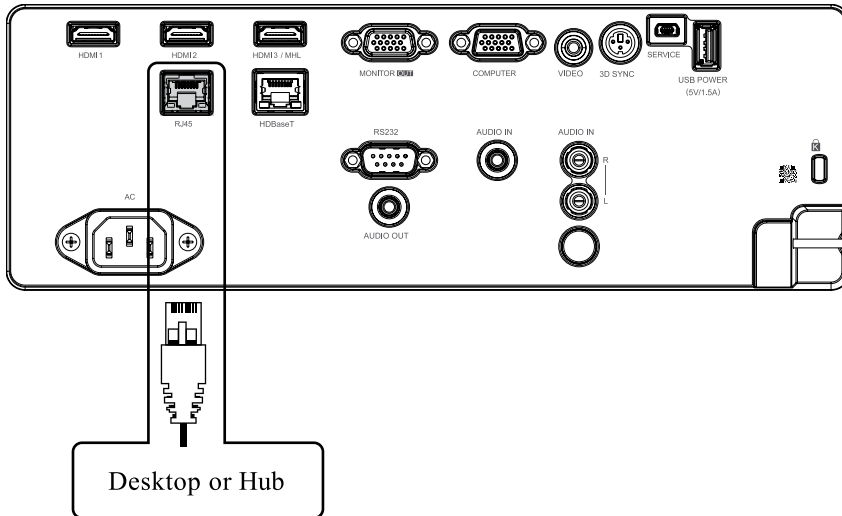

USB POWER (5V/1.5A) connection

Connect a USB cable for USB device. Support 5V/1.5A output as long as the projector is powered on.

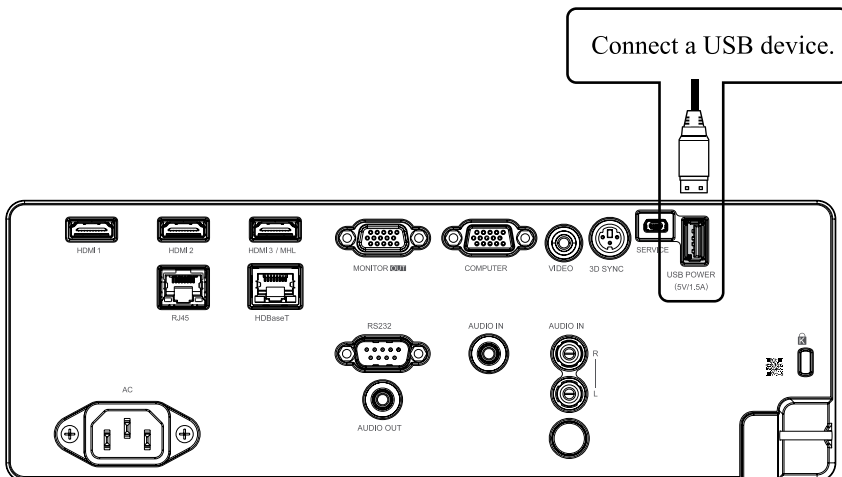

Projector installation

3D SYNC connection

Connect 3D IR glasses receiver unit.

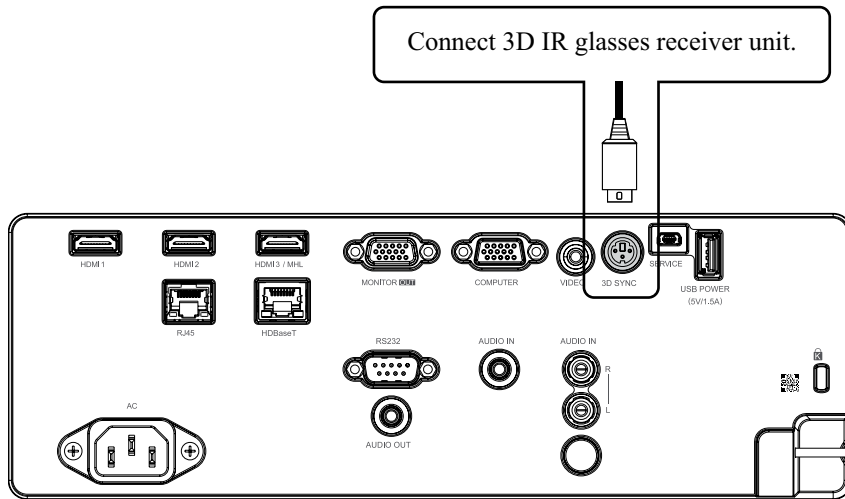

VIDEO connection

Connect the composite cable from a video device.

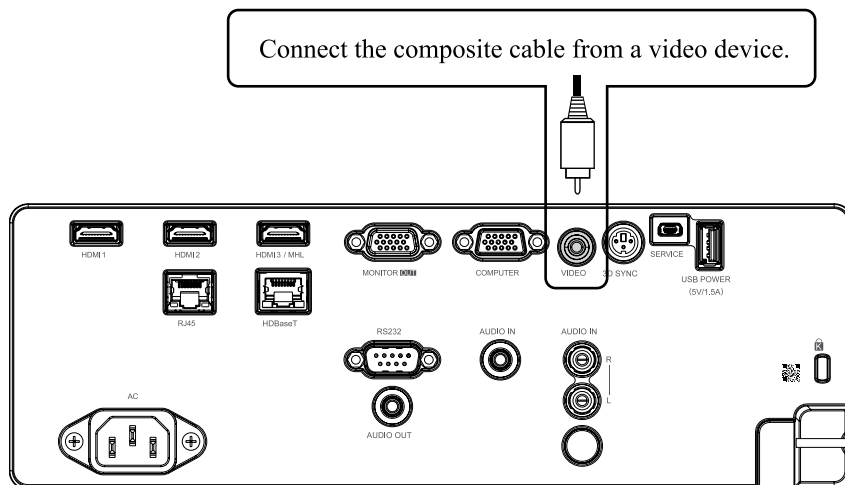

SERVICE connection

For service personnel only.

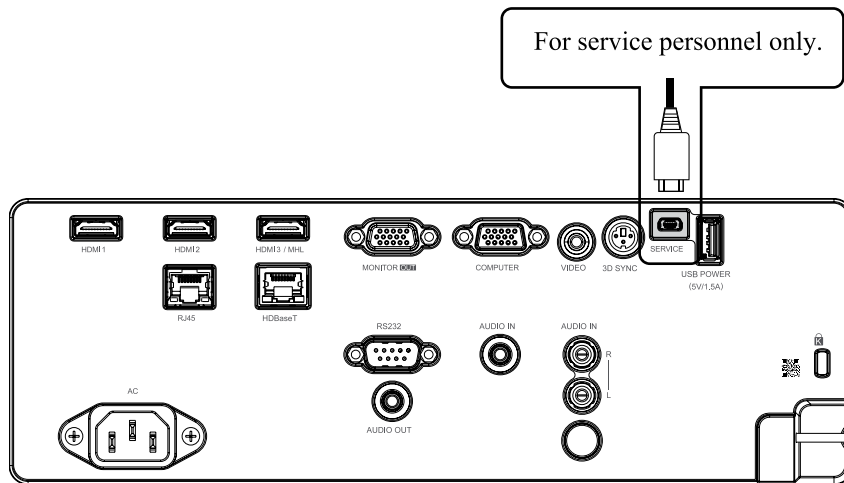

RS232C connection

Connects to the computer by RS-232 communication, the projector can be controlled with RS-232 commands from the computer.

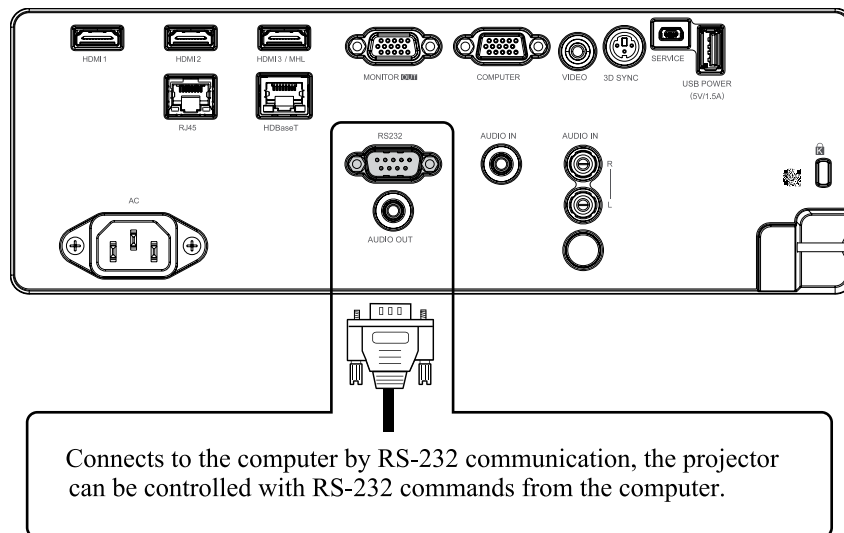

Projector installation

Audio IN (L/R) connection

Connect an audio source input (Available for video source).

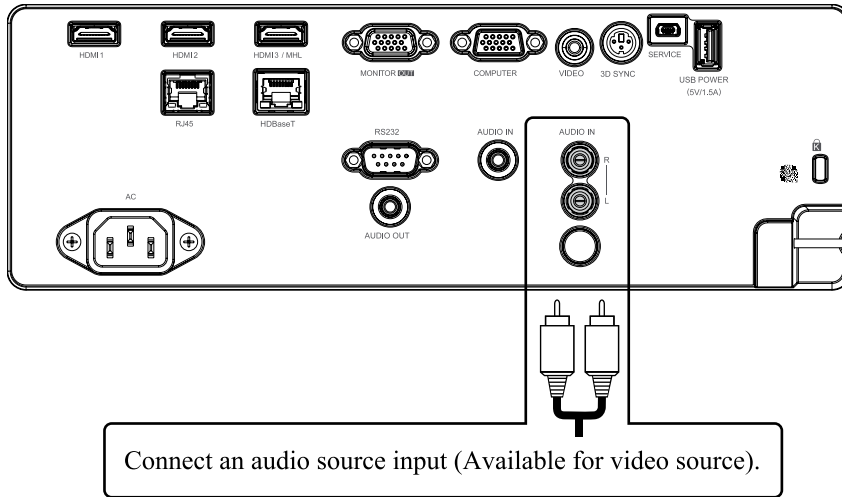

Audio OUT (Mini jack) connection

Connect to an audio amplifier device.

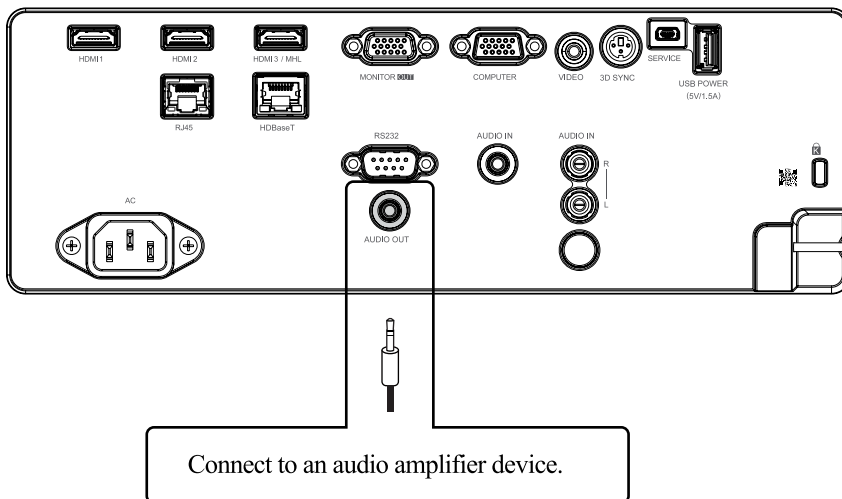

Audio IN (Mini jack) connection

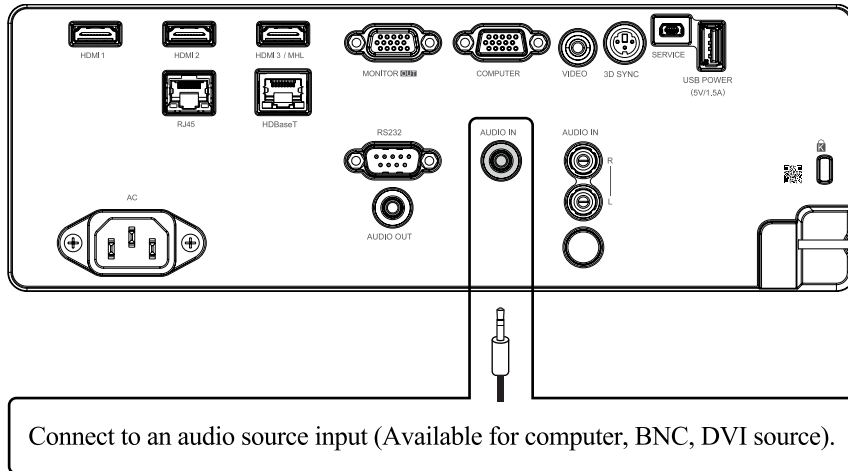

Connect an audio source input (Available for computer, BNC, DVI source).



Projector installation

Powering the projector on or off

Powering on the projector

Press  on the projector or  on the remote control to start up the projector.



The POWER LED will now flash green. The startup screen will display in approximately 10 seconds. The first time you use the projector, you can select your preferred language from the quick menu after the startup screen display.

If security lock is enabled, refer to Page 40 : “Setting an access password (security lock)”.

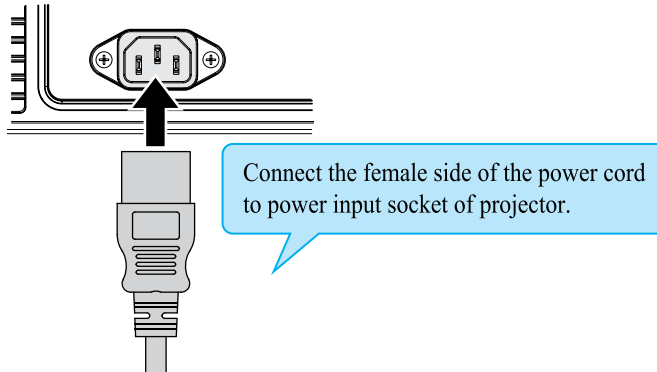
Connect the power cord to the projector



Turning off the projector

Press  on the projector or  on the remote control. The message “Power Off? /Press Power again” will appear on the screen. Press the button again while the message appears. When the projector has been turned off, the cooling fan will remain in operation for approximately 5 seconds.

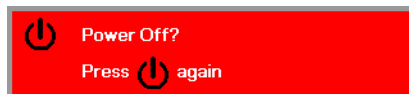

Selecting an input source

If more than one input device is connected, press **SOURCE** and press **▲▼** to scroll among devices. (Component is supported through the RGB to Component adapter.)

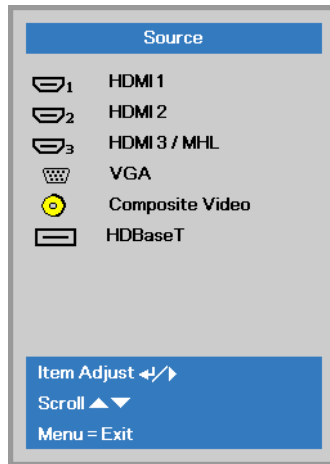

- HDMI 1: High-Definition Multimedia Interface compatible
- HDMI 2: High-Definition Multimedia Interface compatible
- HDMI 3 / MHL: High-Definition Multimedia Interface and Mobile High-Definition Link compatible
- VGA: Analog RGB DVD input YCbCr/ YPbPr, or HDTV input YPbPr via D-sub connector
- Composite Video: Traditional composite video
- HDBaseT: Digital Video through the HDBaseT transmitter

Note: It is recommended to use a certified TX box for the HDBaseT function. Using a single HDBaseT CAT5e cable, the projector supports an HDBaseT connection distances to 100m/328ft.

Projector installation

Setting an access password (security lock)

You can use the four (arrow) buttons to set a password and prevent unauthorized use of the projector. When enabled, the password must be entered after you power on the projector.

Note: Keep the password in a safe place. Without the password, you will not be able to use the projector. If you lose the password, contact your dealer for information on clearing the password.

1. Press **MENU** to open the OSD menu.

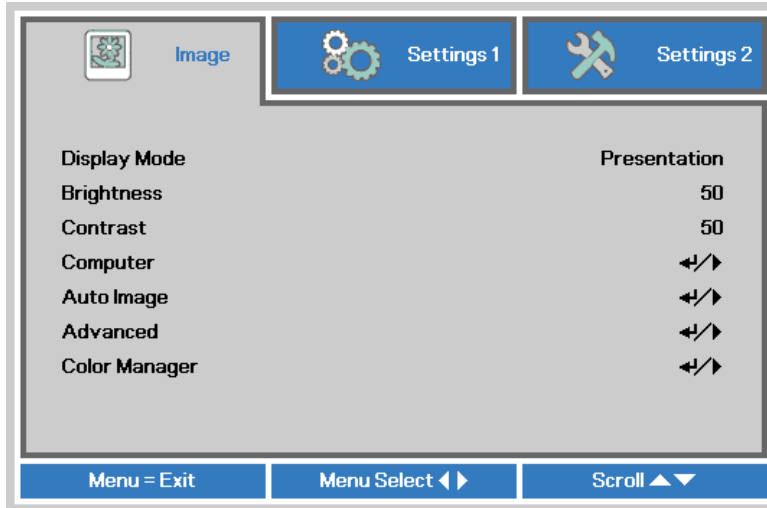

2. Press ◀▶ to move to the **Settings 1** menu and press ▲▼ to select **Advanced 1**.

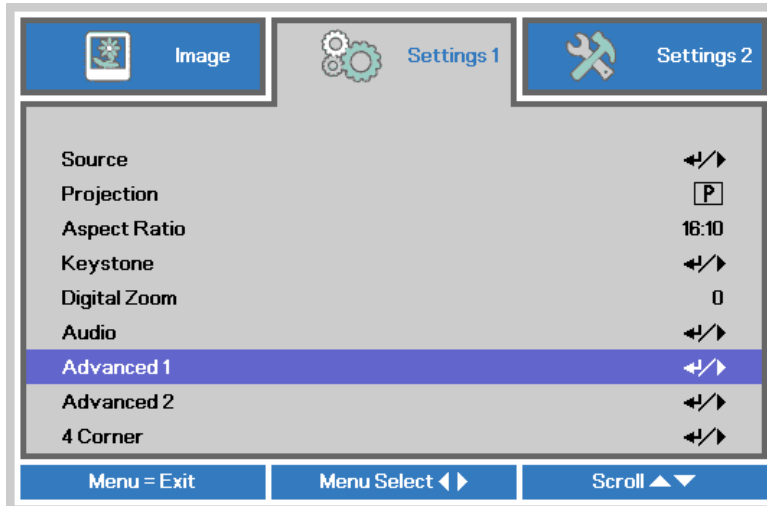

3. Press **ENTER** / **▶** to enter the **Advanced 1** sub menu. Press **▲▼** to select **Security Lock**.
4. Press **◀▶** to enter and enable or disable security lock function.

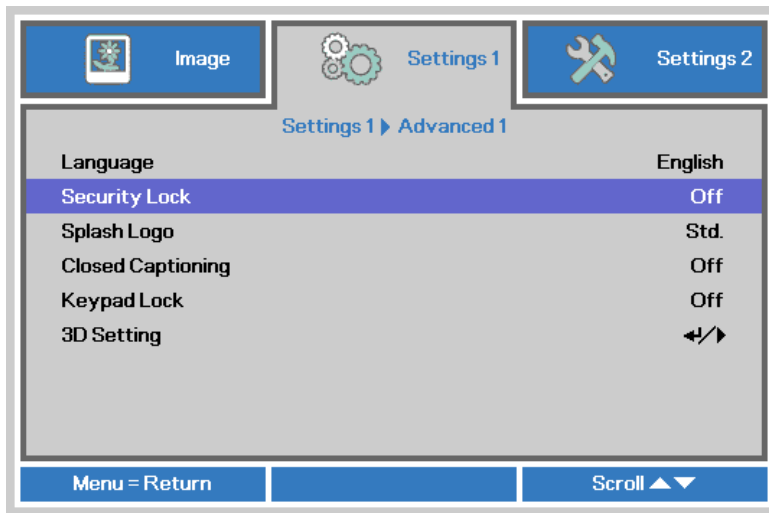

A password dialog box automatically appears.

5. Press **▲▼◀▶** either on keypad or IR remote control for password entry. You can use any combination including the same arrow five times, but not less than five.

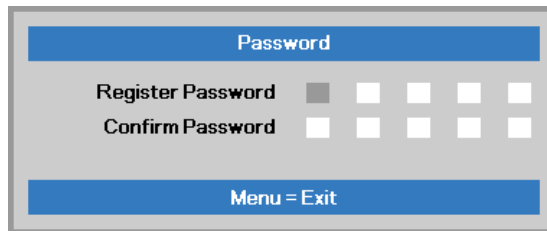

Press **▲▼◀▶** in any order to set the password. Push **MENU** button to exit the dialog box.

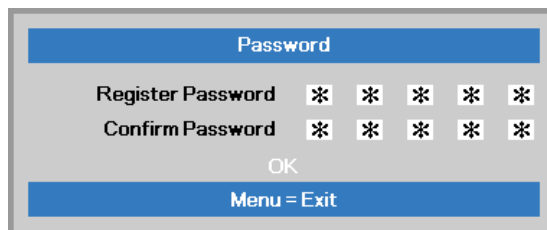

6. The password confirm menu appears when user presses the power-on key in case the Security Lock is enabled. Enter the password in the order you set it at step 5. In case you forget the password, please contact the service center.

The service center will validate the owner and help reset the password.

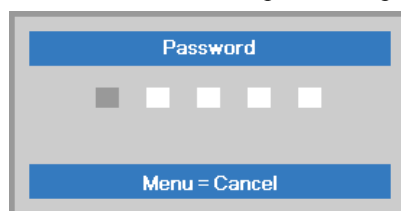

Projector installation

Choosing a location

By default, the projector is configured for “Normal”. If you choose to install your projector in other setups, be sure to adjust the screen orientation to achieve the correct projection mode.

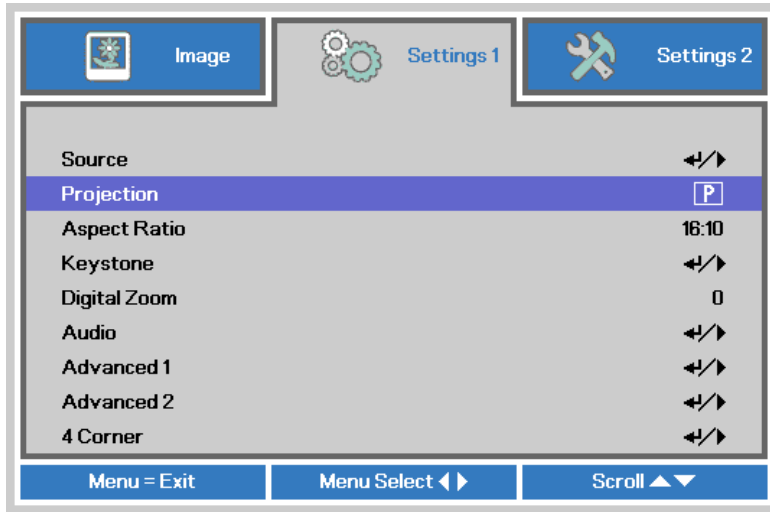

Ceiling **d**

Press **MENU** → **Settings 1** → **Projection**, select **Ceiling**, the projector is now configured for “Ceiling”.

Correct Picture

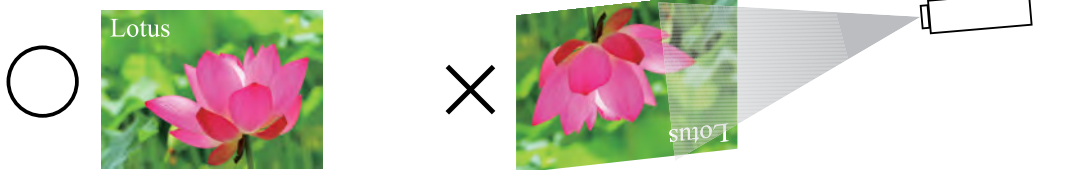

Rear **q**

Press **MENU** → **Settings 1** → **Projection**, select **Rear**, the projector is now configured for “Rear”.

Correct Picture

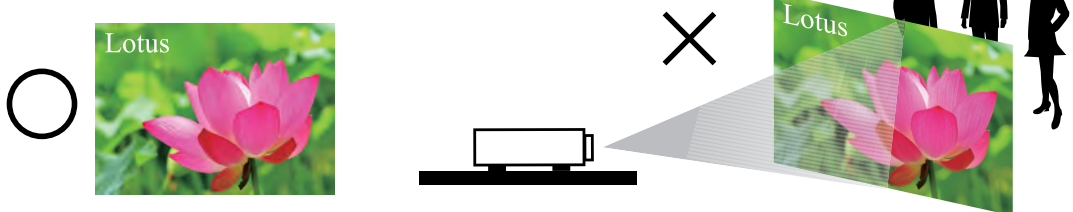

Rear + Ceiling

Press **MENU** → **Settings 1** → **Projection**, select Rear + Ceiling, the projector is now configured for “Rear + Ceiling”.

Correct Picture

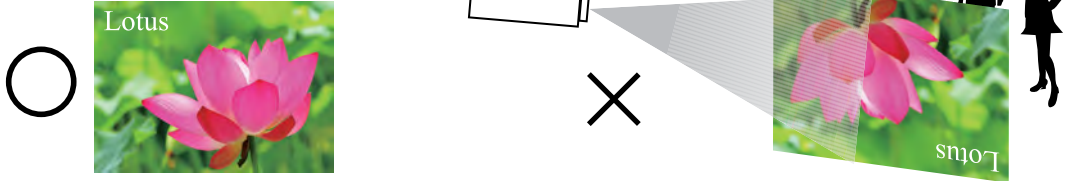

Adjusting the projector's angle

Use the adjustable feet to change the angle of the projector in order to achieve the most suitable angle for projection on the screen.

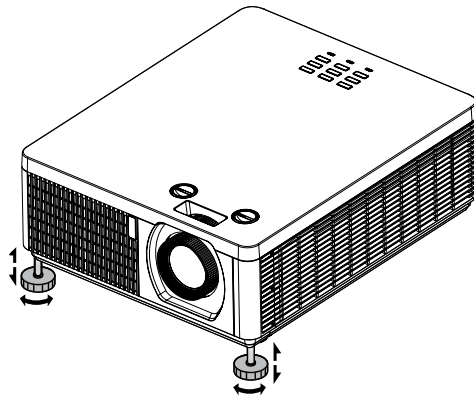

Adjusting the projector's zoom and focus

Zoom

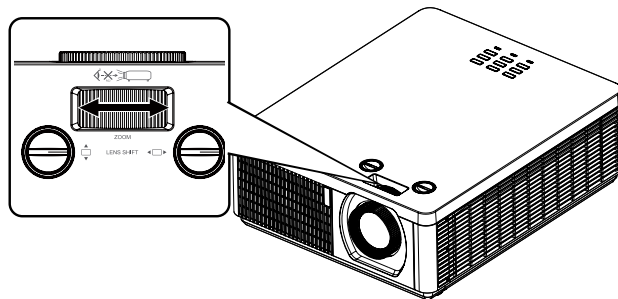

Projector installation

Focus

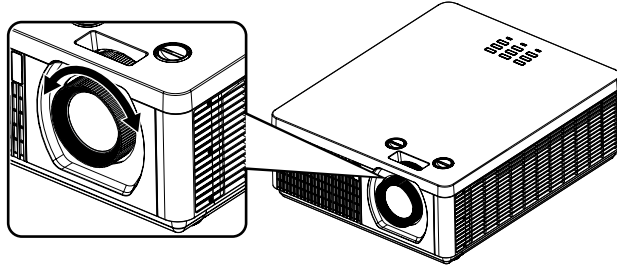

Note for adjusting the zoom/focus

1. Adjust the lens shift/zoom/focus after 30 minutes have passed since the projector turned on.
2. Slight changes of the image position and/or focus may occur within 30 minutes after the projector was turned on. If the room temperature and humidity have changed after adjusting the lens shift/zoom/focus, readjust them as necessary.
3. Set the image size including the margin from the screen edge in anticipation of the changes after installation.

Correcting keystone

1. To adjust keystone, press ▼▲◀▶ on the keypad or remote control and press ▼▲◀▶ to adjust Vertical or Horizontal Keystone. Refer to Fig 2 and 3.
2. To adjust keystone, press the MENU button on the keypad or remote control and choose **Settings 1** → **Keystone** adjust and press ▼▲◀▶ to adjust Vertical and Horizontal Keystone. Refer to Fig 2 and 3.

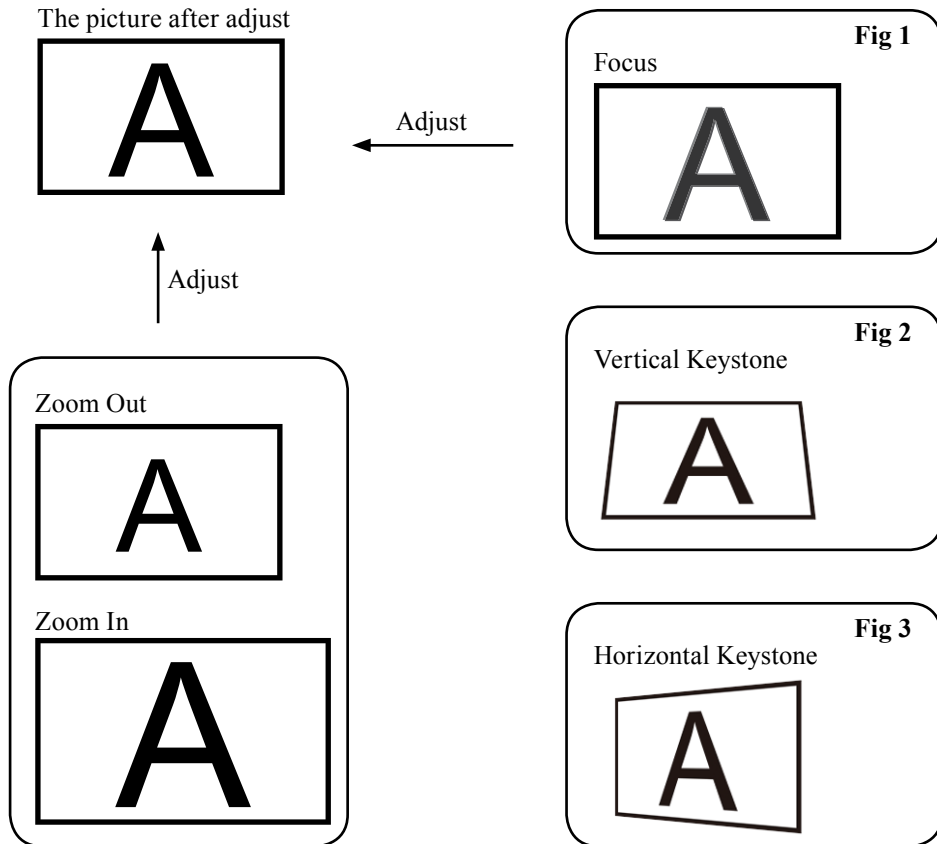

OSD menu tree

OSD menu tree

1st layer	2nd layer	3rd layer	4th layer	Selections			
Image	Display Mode			Presentation, Bright, Game, Movie, Vivid, TV, sRGB, DICOM SIM., User1, User2			
		Brightness		0 ~ 100			
		Contrast		0 ~ 100			
	Computer		Horizontal Position		-5 ~ 5 (depend on Auto Sync)		
			Vertical Position		-5 ~ 0 (depend on Auto Sync)		
			H Phase		0 ~ 31		
			Tracking		-5 ~ 5		
	Auto Image		Brilliant Color		0 ~ 10		
			Sharpness		0 ~ 31		
			Gamma		1.8, 2.0, 2.2, 2.4, B&W, Linear		
			Color Temperature		Warm, Normal, Cold		
			Video AGC		Off, On		
		Advanced		Video Saturation		0 ~ 100	
				Video Tint		0 ~ 100	
			White Balance		R Gain		0 ~ 200
					G Gain		0 ~ 200
					B Gain		0 ~ 200
				R Offset		-100 ~ 100	
		G Offset			-100 ~ 100		
		B Offset			-100 ~ 100		

1st layer	2nd layer	3rd layer	4th layer	Selections
Image	Color Manager	Red	Hue	0 ~ 100
			Saturation	0 ~ 100
			Gain	0 ~ 100
		Green	Hue	0 ~ 100
			Saturation	0 ~ 100
			Gain	0 ~ 100
		Blue	Hue	0 ~ 100
			Saturation	0 ~ 100
			Gain	0 ~ 100
		Cyan	Hue	0 ~ 100
			Saturation	0 ~ 100
			Gain	0 ~ 100
		Magenta	Hue	0 ~ 100
			Saturation	0 ~ 100
			Gain	0 ~ 100
		Yellow	Hue	0 ~ 100
			Saturation	0 ~ 100
			Gain	0 ~ 100
		White	Red	0 ~ 100
			Green	0 ~ 100
			Blue	0 ~ 100

1st layer	2nd layer	3rd layer	4th layer	Selections	
Settings 1	Source			HDMI 1, HDMI 2, HDMI3 / MHL, VGA, Composite Video, HDBaseT	
	Projection		P q d b	Normal, Rear, Ceiling, Rear+Ceiling	
	Aspect Ratio			16:10, 4:3, 16:9, Letter Box, Native, 2.35:1	
	Keystone			H: -50 ~ +50 V: -60 ~ +60	
	Digital Zoom			-10 ~ 10	
	Audio		Volume		0 ~ 20
			Mute		Off, On

OSD menu tree

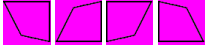
1st layer	2nd layer	3rd layer	4th layer	Selections		
Settings 1	Advanced 1	Language		English, Français, Deutsch, Español, Português, 簡體中文, 繁體中文, Italiano, Norsk, Svenska, Nederlands, Русский, Polski, Suomi, Ελληνικά, 한국어, Magyar, Čeština, العربية, Türkçe, Việt, 日本語, فارسی, תיבטע, Dansk, Fran. can.		
			Security Lock	Off, On		
			Splash Logo	Std, Black, Blue		
			Closed Captioning	Off, On		
			Keypad Lock	Off, On		
			3D Setting	3D	Off, DLP-Link, IR	
				3D Sync Invert	Off, On	
				3D Format	Frame Sequential, Top/Bottom, Side-By-Side, Frame Packing (3D FramePacking HDMI source only)	
			Advanced 2	Test Pattern		None, RGB Ramps, Color Bars, Step Bars, Checkboard, Grid, Horizontal lines, Vertical lines, Diagonal lines, Horizontal Ramp, Vertical Ramp, White, Red, Green, Blue, Black
					H Image Shift	-50 ~ 50
					V Image Shift	-50 ~ 50
			4 Corner			0 ~ 60

1st layer	2nd layer	3rd layer	4th layer	Selections	
Settings 2			Auto Source	Off, On	
			No Signal Power Off	0 ~ 180	
			Auto Power On	Off, On	
			Laser Mode	Normal, Eco, Eco Plus, Dimming, Extreme Dimming, Custom Light	
			Reset All		
			Status	Active Source	
				Video Information	
				Laser Hours	
				Software Version	
				Remote ID	
					Serial Number

1st layer	2nd layer	3rd layer	4th layer	Selections	
Settings 2	Advanced 1	Menu Position			
		Translucent Menu		0%, 25%, 50%, 75%, 100%	
		Low Power Mode		On, On by LAN	
		Fan Speed		Normal, High	
		Laser Info		Normal, Eco, Eco Plus, Dimming, Extreme Dimming, Custom Light	
		Remote ID		Default, 1, 2, 3, 4, 5, 6, 7	
				Network State	
				DHCP	
				IP Address	
			Network	Subnet Mask	
				Gateway	
				DNS	
				Apply	
		HDBaseT/IR	HDBaseT-IR/RS232/RJ45	Off, On	
			Front IR	On, Off	
			Rear IR	On, Off	
			Sleep Timer	0 ~ 600	
		Advanced 2	HDMI 1	Disable, Enable	
			HDMI 2	Disable, Enable	
			HDMI 3 / MHL	Disable, Enable	
			VGA	Disable, Enable	
			Composite Video	Disable, Enable	
			HDBaseT	Disable, Enable	
	Custom Light			25 ~ 100	

OSD description

OSD description

1. Press **MENU** on the remote control or on the side of the projector to bring up the OSD menu.
2. You will see three main menus (Image, Settings 1 and Settings 2).
3. Press ◀▶ to move to the main menu. Press ▲▼ to select the desired sub menu. Press ◀▶ to enter and change values for settings.
4. Press **MENU** to return to the previous menu.
5. From the main menu, press **MENU** to close the OSD menu.
6. Some items do not work at the condition of Source, Input signal and Menu setting.
7. Picture may be incorrect when the parameter value is exceeded.

Image

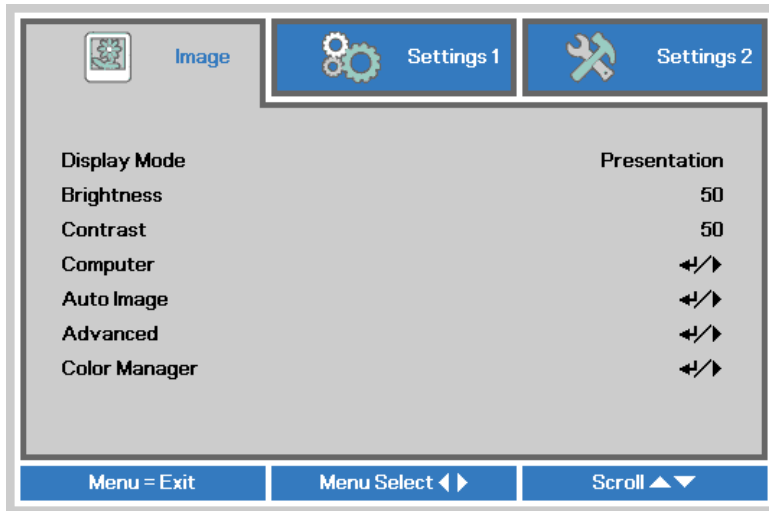

Display Mode

Press ◀▶ to select a display mode.

- **Presentation**

Use this mode in a typical office situation. The brightness of this mode is between Bright and Game.

- **Bright**

When projector in the high ambient light conditions, you can select this mode to get the brightness image Performance. Use this mode in high ambient light situations.

- **Game**

Suitable for playing video games in a bright living room.

- **Movie**

For home theater.

- **Vivid**

With well-saturated color, fine-tuned sharpness and a higher brightness level, this is perfect for watching movies in a living room where there is a small amount of ambient light.

- **TV**

Display mode adjusts the settings to offer a more television-like experience.

- **sRGB**

Maximizes the purity of RGB colors to provide true-to-life images regardless of brightness setting. It is most suitable for viewing photos taken with an sRGB compatible and properly calibrated camera, and for viewing PC graphic and drawing applications such as AutoCAD.

• DICOM SIM

This display mode simulates the grayscale/gamma performance of equipment used for “Digital Imaging and Communications in Medicine” (DICOM).

Important: This mode should NEVER be used for medical diagnosis, it is for education/training purposes only.

• User1, User2

Recalls the settings customized based on the current available picture modes.

Note: Valid only when Display Mode is USER1/2 and input is RGB signal.

Brightness

Press ◀▶ to adjust the brightness of the projected picture. You can connect the projector to an external picture source to display a picture resembling the one shown (PLUGE: Picture Line-Up Generation Equipment) for adjustment. Although there are numerous versions of PLUGE picture, they are typically comprised of blocks of black, white and gray on top of a black background.

It is recommended that you adjust the picture to the following status:

- The darkest black bar of the picture should disappear into the background.
- The dark gray area should be barely visible.
- The light gray area should be clearly visible.
- The white area should appear real and mellow.
- The picture should only display black, gray and white (with no other colors).

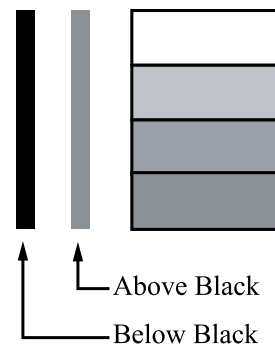

Note: Contrast, Brightness, Color and Tint are interrelated options that affect one another; when you adjust one of them, you might have to fine tune other settings to get the best projection results.

Fig 4 on Page 54 illustrates the results of direct brightness adjustment using a random picture:

Contrast

Press ◀▶ to adjust the contrast of the projected picture. You can connect the projector to an external picture source to display a picture resembling the right figure for adjustment. It is recommended that you adjust the projected picture according to the results shown in the right figure so that the brightness of the spectrum remains constant throughout and achieves maximum contrast between black and white.

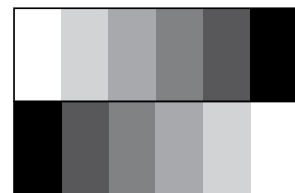

Fig 5 on Page 54 illustrates the results of direct contrast adjustment using a random picture:

OSD description

Computer

Press **ENTER** / **▶** to enter the **Computer** menu.

- **Horizontal Position**

Press **◀▶** to adjust the projected picture's horizontal position.

If the projected picture is not at the center of the screen (i.e. shifted to right or left) and ends up being cropped, use this function to adjust the picture's horizontal position. The following picture is an example of test picture from an external signal source:

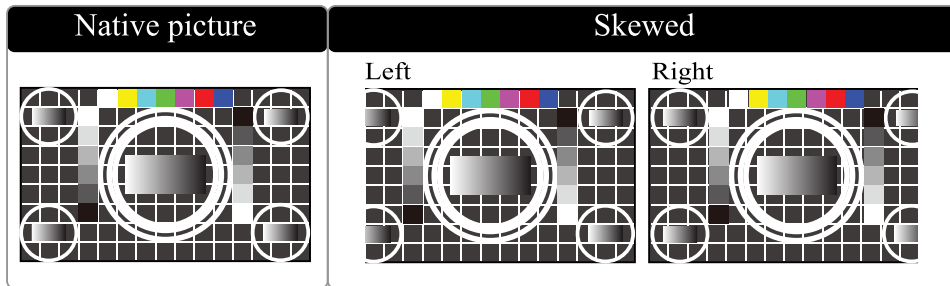

- **Vertical Position**

Press **◀▶** to adjust the projected picture's vertical position.

If the projected picture is not at the center of the screen (i.e. shifted up or down) and ends up being cropped, use this function to adjust the picture's vertical position. The following picture is an example of test picture from an external signal source:

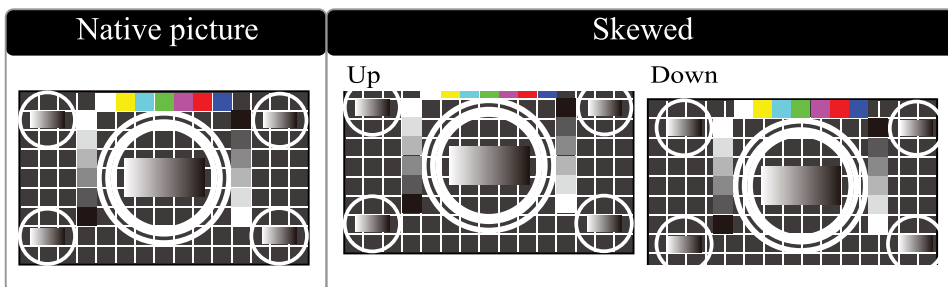

It is recommended that when adjusting the picture, the horizontal total should be adjusted before the horizontal phase. However, if the picture still flickers even after you have adjusted both, try lowering the picture noise.

- **H Phase**

Press **◀▶** to adjust the projected picture's phase.

Use this function to adjust the phase of pixel sampling clock (relative to input signal). Should the picture still flicker or show noise (i.e. edges on texts) after optimization, adjust phase accordingly.

- **Tracking**

Press **◀▶** to enter and adjust the A/D sampling dot.

Auto Image

When Auto image was selected in the OSD menu, press **ENTER** to execute the automatic picture adjustment function.

By executing this function, the projector will resync the picture. Use this function when the picture source is unstable or when you notice deterioration in picture quality and the projector will automatically adjust the picture size, phase and timing. (The adjustment also applies to PinP input source).

This function is identical to **AUTO** on the remote control. You can simply use the hot key on the remote control to execute this function.

Advanced

Press **ENTER** / **▶** to enter the **Advanced** menu.

- **Brilliant Color**

Press **◀▶** to adjust the brilliant color of the projected image.

This feature utilizes a new color-processing algorithm and system level enhancements to enable higher brightness while providing truer, more vibrant colors.

- **Sharpness**

The adjustment of sharpness primarily changes the value of high frequency detail. You can connect the projector to an external picture source to display a picture resembling the one shown below to adjust the picture sharpness.

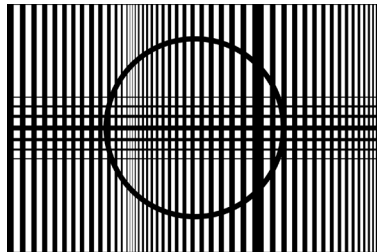

Fig 8 on Page 54 illustrates the results of direct sharpness adjustment using a random picture:

- **Gamma**

This function can change the gamma-characteristic.

You can choose gamma from 1.8/2.0/2.2/2.4/B&W/Linear.

- **Color Temperature**

You can choose from Warm, Normal and Cold.

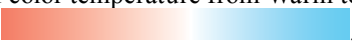
Color temperature refers to the change in light color under different energies that is perceived by the naked eye. The change of color temperature from Warm to Cold for visible light goes from orange red → white → blue .

As color temperature rises, the picture will appear to be bluer; as it decreases, the picture will appear redder. When you choose “Native”, the projector will disable the white adjustment function of the input device.

- **Video AGC**

Press **◀▶** to enter and enable or disable the Automatic Gain Control for video source.

OSD description

- **Video Saturation**

Press ◀▶ to adjust the color saturation of the projected image.

Fig 6 illustrates the results of direct brightness adjustment using a random picture:

- **Video Tint**

Press ◀▶ to adjust the ratio of red to green in the color portion of the image.

Fig 7 illustrates the results of direct brightness adjustment using a random picture:



• White Balance

Regardless of the change in ambient light, the human eye is equipped with an automatic adjustment mechanism that makes a white object appear white and black object black. However, since no machine has such an incredible innate feature, you may need to make certain adjustments to the projector's settings when the ambient light changes so that the picture will appear closer to the actual colors.

Gain

This refers to the control of color imbalance in the brighter areas of the projected picture. It is recommended that you use an external test picture with many areas of white (i.e. a picture of 80IRE-window). If you notice minimal amount of red, green or blue in the gray areas, lower the gain of the corresponding color accordingly. This function is used to increase or decrease the range of color input for the entire picture.

Generally speaking, as gain increases, the contrast of the picture will become lower. By increasing the offset, the picture brightness will become lower.

Offset

This refers to the control of color imbalance in the darker areas of the projected picture. It is recommended that you use an external test picture with many areas of dark and gray colors (i.e. a picture of 30IRE-window). If you notice minimal amount of red, green or blue in the gray areas, adjust the offset of the corresponding color accordingly. This function will shift the entire color spectrum for the whole picture and change its brightness.

• Red Gain

Press ◀▶ to adjust the gain of red in bright scales.

• Green Gain

Press ◀▶ to adjust the gain of green in bright scales.

• Blue Gain

Press ◀▶ to adjust the gain of blue in bright scales.

• Red Offset

Press ◀▶ to adjust the offset of red in dark scales.

• Green Offset

Press ◀▶ to adjust the offset of green in dark scales.

• Blue Offset

Press ◀▶ to adjust the offset of blue in dark scales.

This function is available only when Display Mode is set to USER-1/2 and the input is RGB signal.

Color Manager

This function can be used to adjust the colors.

Red, Green, Blue, Cyan, Magenta, Yellow can be adjusted by Hue, Saturation, Gain.

White can be adjusted by the Gain of Red, Green and Blue.

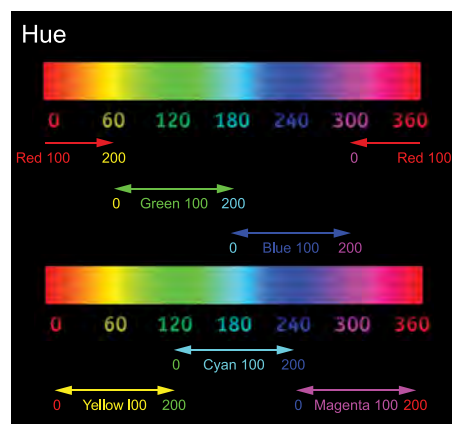

OSD description

Settings 1

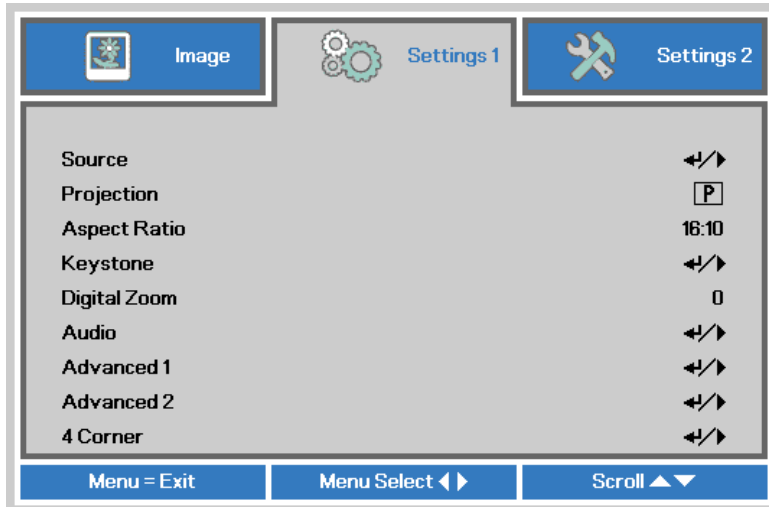

Source

This function is same as the hotkey which on Remote controller. You can use remote controller or this function to select the correct input source.

- **HDMI1**
HDMI input from PC or media device.
- **HDMI2**
HDMI input from PC or media device.
- **HDMI3 / MHL**
Connect to a MHL-compatible device by using an HDMI/MHL cable.
- **VGA**
Analog RGB from PC.
- **Composite Video**
Video input from traditional composite video.
- **HDBaseT**
Uncompressed digital video from HDBaseT device.

Projection

Use these function to install the projection mode. Has below 4 mode can select:

- **Normal**
Refer to Page 25 : “Normal” for detailed information.
- **Ceiling**
Refer to Page 26 : “Ceiling” for detailed information.
- **Rear**
Refer to Page 26 : “Rear” for detailed information.
- **Rear + Ceiling**
Refer to Page 26 : “Rear + Ceiling” for detailed information.

Aspect Ratio

Use this function to adjust the aspect ratio of the projected picture. Press ◀▶ to adjust the ratio of picture length and width.

The projector's full picture size is 16:10 (1920×1200 dots). The following diagram illustrates the difference in various aspect ratio settings:

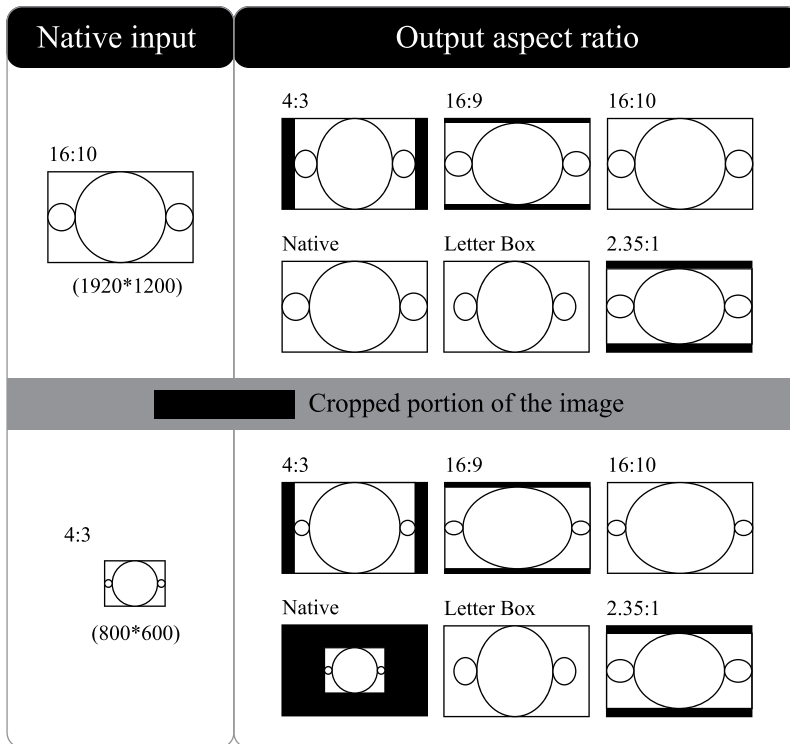

Note: When used for commercial purposes, including: projection of picture in movie theaters, hotels, cafeteria and other public venues, compression or extension of picture achieved through the change of aspect ratio may constitute copyright infringement to the rightful owner of the picture. Please do so at your own discretion.

Keystone

Press ▲▼◀▶ to correct horizontal keystone due to projection angle. Refer to Page 45 : “Correcting keystone”.

Digital Zoom

Press ◀▶ to zoom in the projected image.

Audio

Press ENTER / ▶ to enter the **Audio** menu.

- **Volume**

Press ◀▶ to enter and adjust the audio volume.

- **Mute**

Press ◀▶ to enter and turn on or off the speaker.

OSD description

Advanced 1

Press **ENTER** / ► to enter the **Advanced 1** menu.

- **Language**

You can use this function to select the language you wish for the OSD menu to be displayed in. The options are English, French, German, Spanish, Portuguese, Simplified_Chinese, Traditional_Chinese, Italian, Norwegian, Swedish, Dutch, Russian, Polish, Finnish, Greek, Korean, Hungarian, Czech, Arabic, Turkish, Vietnamese, Japanese, Thai, Farsi, Hebrew, Danish, French Canadian.

- **Security Lock**

Press ◀▶ to enter and enable or disable security lock function. Refer to Page 40 : “Setting an access password (security lock)”.

- **Splash Logo**

You can use this function to have the projector display the logo in the start up screen. Set “Std” to display the logo during start up.

If you wish to not show the logo while no input is detected, you can change the setting to Black or Blue.

- **Closed Captioning**

Press ◀▶ to enter and enable or disable Closed Captioning.

- **Keypad Lock**

Press ◀▶ to enter and enable or disable keys can be work on keypad.

Note: Hold ▼ on keypad for 5 seconds to unlock keypad.

- **3D Setting**

Press **ENTER** / ► to enter the **3D Setting** menu.

- **3D**

Press ◀▶ to enter and select different 3D mode. The options are Off, DLP-Link and IR.

- **3D Sync Invert**

Press ◀▶ to enable or disable 3D Sync Invert.

- **3D Format**

Press ◀▶ to select the 3D format. The options are Frame Sequential, Top/Bottom, Side-By-Side, Frame Packing.

Note: 3D Frame Packing HDMI source only.

Note: The 3D OSD menu item is gray if there is no appropriate 3D source. This is the default setting.

Note: When the projector is connected to an appropriate 3D source, the 3D OSD menu item is enabled for selection.

Note: Use 3D glasses to view a 3D image.

Note: You need 3D content from a 3D DVD or 3D media file.

Note: You need to enable the 3D source (some 3D DVD content may have a 3D on-off selection feature).

Note: You need DLP link 3D or IR 3D shutter glasses. With IR 3D shutter glasses, you need to install a driver on your PC and connect a USB emitter.

Note: The 3D mode of the OSD needs to match the type of glasses (DLP link or IR 3D).

Note: Power on the glasses. Glasses normally have a power on -off switch. Each type of glasses has their own configuration instructions. Please follow the configuration instructions that come with your glasses to finish the setup process.

Note: Passive 3D is not going to support thru 3D Sync In/Out.

Note: Since different types of glass (DLP link or IR shutter glass) have their own setting instructions, please follow the guide to finish the setup process.

Advanced 2

Press **ENTER** / **▶** to enter the **Advanced 2** menu.

- **Test Pattern**

The projector comes with some standard built-in patterns for testers to calibrate the equipment.

The options are RGB Ramps, Color Bars, Step Bars, Checkboard, Grid, Horizontal lines, Vertical lines, Diagonal lines, Horizontal Ramp, Vertical Ramp, White, Red, Green, Blue, Black and Off.

- **H Image Shift**

Press **◀▶** to enter and set whole Image horizontal shift without cropped.

- **V Image Shift**

Press **◀▶** to enter and set whole Image vertical shift without cropped.

4 Corner

Press **▲▼◀▶** to correct 4 corner picture bias.

Press **▲▼◀▶** to correct top left corner picture bias



Press **▲▼◀▶** to correct top left corner picture bias



Press **▲▼◀▶** to correct bottom left corner picture bias



Press **▲▼◀▶** to correct bottom right corner picture bias



OSD description

Settings 2

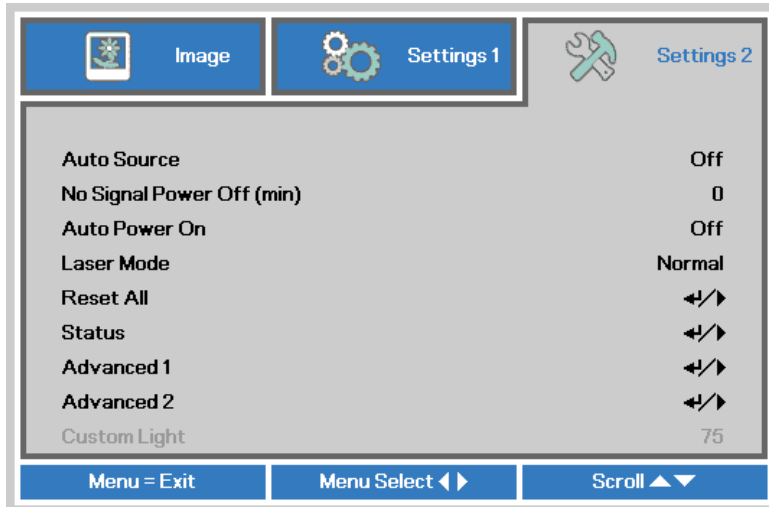

Auto Source

- **ON**

By enabling this function, the projector will automatically determine the source of input every time it is turned on so that the user will not have to make the selection on the OSD menu.

- **OFF**

Setting the function off will require the user to specify source of picture input on the OSD menu in order for the projector to display the intended picture.

No Signal Power Off

Allows the projector to turn off automatically if no input signal is detected after a set period of time. When this setting is set to 0, this function is invalid.

Auto Power On

If you set this function to On, the light source will be automatically turned on without usual procedure, when the AC power is cut off during the light source was on and it is supplied again.

The light source will not be turned on automatically even when the AC power is supplied after the following procedures. Please turn on the light source with the usual procedure.

- The light source was turned off with the normal procedure.
- The light source was turned off when this function is set to Off.

Laser Mode

- **Normal**

Brightness will be 100% when set to Normal mode. If the projection environment requires brighter picture, you can set the power mode to Normal for the highest projection brightness.

Note: When the temperature is higher than 35°C (95°F), the brightness will be 60% automatically.

- **Eco**

When set to Eco mode, the brightness will be 80% of the normal brightness.

- **Eco Plus**

When set to Eco Plus mode, the brightness will be 60% of the normal brightness.

- **Dimming**

When set to Dimming mode, the brightness will be 40% of the normal brightness.

- **Extreme Dimming**

When set to **Extreme Dimming** mode, the brightness will be 25% of the normal brightness. The cooling fan will slow down the speed. If the surrounding environment is sufficiently dark or if you do not require intense brightness, you can set the power mode to **Extreme Dimming** to save the power.

- **Custom Light**

If the picture brightness at **Extreme Dimming** mode is too dark for you and the Normal mode gets too bright, you can set it to custom to specify the power mode to make fine adjustments to the brightness of the projected picture. You could encounter situations where the picture from projector A being brighter than projector B. When this occurs, you can use this function you could encounter situations where the picture from projector A being brighter than projector B. When this occurs, you can use this function to fine tune the brightness of the two projectors to achieve consistent picture brightness. To access this function, go to the **MENU → Settings 2 → Laser Mode → Custom Light** and adjust accordingly.

Reset All

Press **ENTER / ►** to reset all settings to default values.

Note: All of OSD function are reset to default except Language, Security Lock, Source, 3D(include Sync Invert & Format), Test Pattern, Remote ID, Network.

Status

Press **ENTER / ►** to enter the **Status** menu.

- **Active Source**

Display the activated source.

- **Video Information**

Displays resolution/video information for RGB source and color standard for Video source.

- **Laser Hours**

Laser hour used information is displayed.

- **Software Version**

Showing system software version.

- **Remote ID**

Showing Remote Controller ID.

- **Serial Number**

Showing serial number of product.

Advanced 1

Press **ENTER / ►** to enter the **Advanced 1** menu.

- **Menu Position**

You can use this function to designate which area on the picture the OSD menu will appear. As you can see from the diagram below, there are five positions where you can choose to have the OSD menu displayed. The default setting is "Center".

- **Translucent Menu**

Press **◀▶** to enter and select OSD background translucent level.

- **Low Power Mode**

Press **◀▶** to enter and turn Low Power Mode On or On By Lan.

Note: About "On By Lan", RJ45 will support to be waked up in this mode(Under 3W) but scalar won't.

OSD description

• Fan Speed

Use this function to control the projector's cooling fan. You can set it to Normal or High. The default setting is Normal.

Under normal circumstances, the projector will operate normally with this function set to Normal. By default, the projector will detect the temperature of the surrounding environment to regulate the speed of the cooling fan. When the ambient temperature rises, fan speed will increase (generates louder noise) to make sure the heat inside the projector gets discharged and keep the projector working normally.

However, if you were to operate the projector in environment of excessive heat or in areas of high altitude, the projector may automatically shut down. When this happens, you can enable this function by setting it to High to force the cooling fan to work at a full speed to regulate the temperature inside the projector.

Note: We recommend selecting high speed in high temperatures, high humidity, or high altitude (higher than 1520 meters (5000 feet)) areas. Please refer to Page Page 76.

Note: Due to the air thinning substantially at high altitudes, the result of cooling achieved by the cooling fan is significantly reduced compared to operation on level ground. With low atmospheric pressure and high operating temperature, the cooling fan will not be able to disperse the heat adequately.

Note: When change fan speed need to re-turn on the projector again.

• Laser Info

Press **ENTER** / ► to enter the Laser Info menu to display the laser hours for each laser mode.

• Remote ID

Press ◀► to select remote ID to fit the current remote ID settings. Refer to Page 21 : “Remote control”.

Note: Remoter with Default customer code will be available for any Remote ID setting on the OSD.

Note: Status key will be available for any Remote ID setting on the OSD

Note: IF users forget the current Remote ID setting, please press the Status key to call out the Status OSD to check the current Remote ID setting and then adjust the ID on the remoter to meet the OSD setting.

Note: After adjusting Remote ID from OSD, only if the OSD Menu has been closed then the new ID value can be taken effected and memorized.

Note: The setting value “Default” means ID 0 on the remoter.

• Network

Press **ENTER** / ► to enter the **Network** menu.

• Network State

Projector Control: Choice this fuction to control the projector via the web.

On: This function only for the professional service person. For download command use.

• DHCP

If the projector installation environment has the Dynamic Host Configuration Protocol server.

You can set this function “ON” to let the projector get the auto ID from server. If no DHCP, even you set “ON” for this function. You still need to input the projector ID by yourself.

• IP Address

If has DHCP server and the function is on. The ID address will auto display here , or you need to enter ID by yourself.

• Subnet Mask

If has DHCP server and the function is on. The Subnet Mask address will auto display here , or you need to enter it value by yourself.

- **Gateway**

If has DHCP server and the function is on. The Gateway address will auto display here , or you need to enter it value by yourself.

- **DNS**

If has DHCP server and the function is on. The DNS address will auto display here , or you need to enter it value by yourself.

- **Apply**

Press **ENTER** / ► to confirm settings.

LAN_RJ45

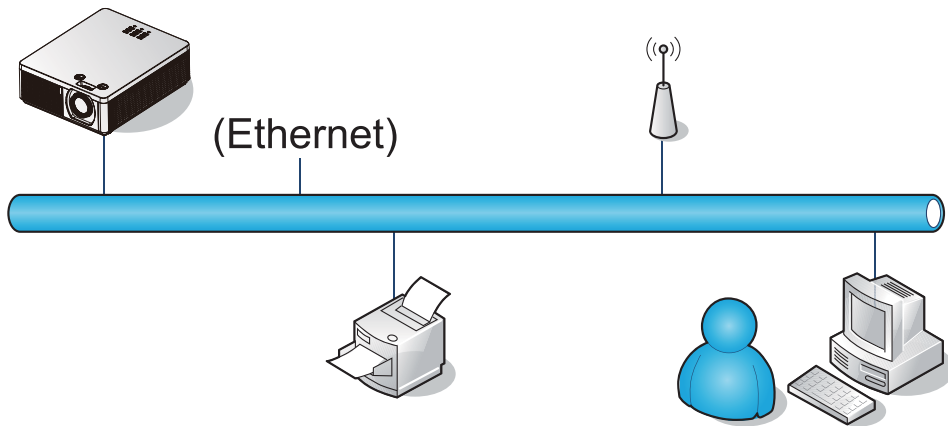

Wired LAN terminal functionalites

Remote control and monitoring of a projector from a PC (or laptop) via wired LAN is also possible. Compatibility with Crestron / AMX (Device Discovery) control boxes enables not only collective projector management on a network but also management from a control panel on a PC (or Laptop) browser screen.

- Crestron is a registered trademark of Crestron Electronics, Inc. of the United States.
- AMX is a registered trademark of AMX LLC of the United States.
- PJLink applied for trademark and logo registration in Japan, the United States of America, and other countries by JBMIA.

Supported External Devices

This projector is supported by the specified commands of the Crestron Electronics controller and related software (ex, RoomView®).

<http://www.crestron.com/>

This projector is supported by AMX (Device Discovery).

<http://www.amx.com/>

This projector supports all commands of PJLink Class1 (Version 1.00).

<http://pjlink.jbmia.or.jp/english/>

For more detail of information about the diverse types of external devices which can be connected to the LAN/RJ45 port and remote/control the projector, as well as the related control commands supporting for each external device, kindly please get contact with the Support-Service team directly.

OSD description

LAN_RJ45

1. Connect an RJ45 cable to RJ45 ports on the projector and the PC (Laptop).

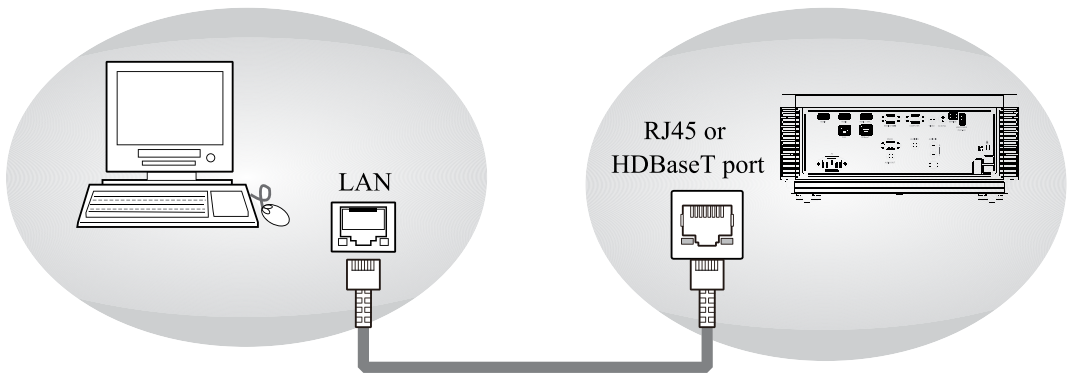

2. On the PC (Laptop), select **Start** → **Control Panel** → **Network and Internet**.

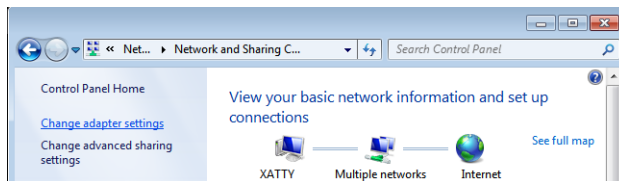
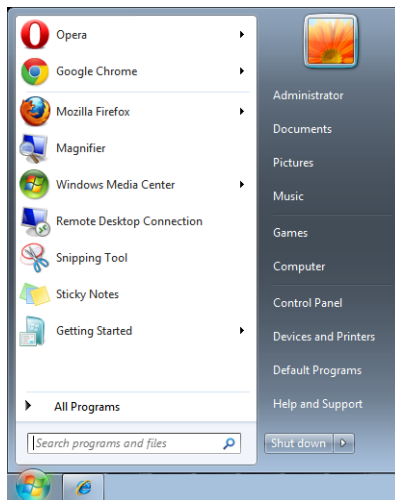

3. Right-click on **Local Area Connection**, and select **Properties**.

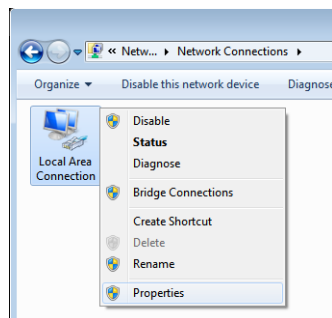

4. In the **Properties** window, select the **Networking** tab, and select **Internet Protocol (TCP/IP)**.
5. Click **Properties**.

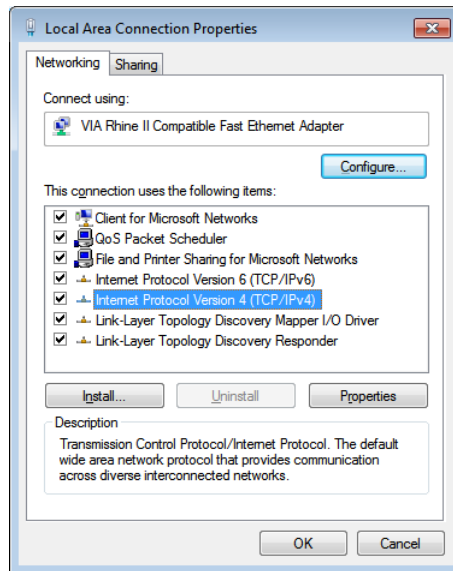

6. Click **Use the following IP address** and fill in the IP address and Subnet mask, then click **OK**.

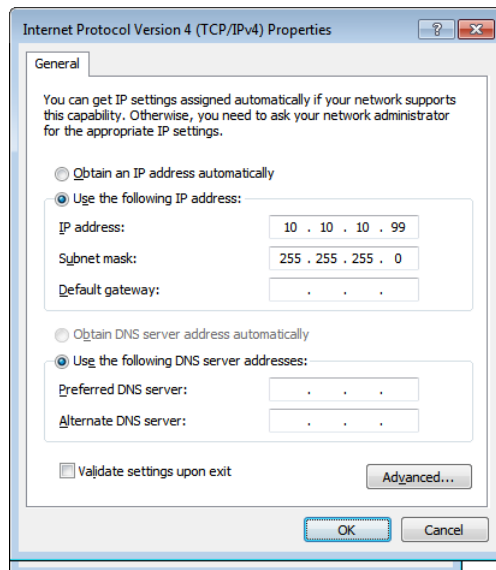

7. Press **MENU** on the projector.
8. Select **MENU** → **Settings 2** → **Advanced 1** → **Network**.
9. After getting into **Network**, input the following:
 DHCP: Off
 IP Address: 10.10.10.10
 Subnet Mask: 255.255.255.0
 Gateway: 0.0.0.0
 DNS Server: 0.0.0.0

OSD description

10. Press **ENTER** / **▶** to confirm settings.

Open a web browser.

(for example, Microsoft Internet Explorer with Adobe Flash Player 9.0 or higher).

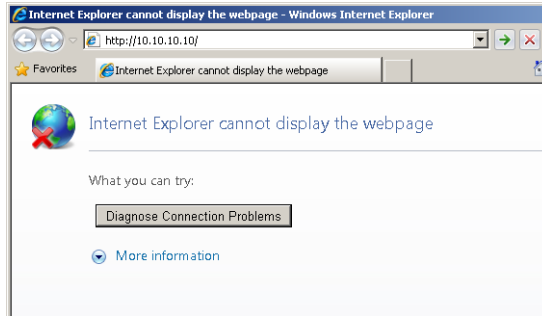

11. In the Address bar, input the IP address: 10.10.10.10.

12. Press **ENTER** / **▶**.

The projector is setup for remote management. The LAN/RJ45 function displays as follows.

Projector Info	
Model Name	
System	
System Status	Power On
Display Source	BNC
Laser Hours	2
Display Mode	Presentation
Error Status	No Error
LAN Status	
IP address	10.10.10.10
Subnet mask	255.255.255.0
Default gateway	0.0.0.0
DNS Server	0.0.0.0
MAC address	00:18:23:50:FF:02
Version	
LAN Version	MHD02_UL
F/W Version	E05



The screenshot shows a configuration window with the following sections:

- Crestron Control:** IP Address, IP ID, Control Port, and a Send button.
- Projector:** Projector Name, Location, Assigned To, and a Send button.
- Network Configuration:** DHCP (checkbox), DHCP Enabled, IP Address (10.10.10.10), Subnet Mask (255.255.255.0), Default Gateway (172.16.7.254), DNS Server (172.16.0.1), and a Send button.
- User Password:** Enabled checkbox, New Password, Confirm, and a Send button.
- Admin Password:** Enabled checkbox, New Password, Confirm, and a Send button.
- Exit:** A large black button at the bottom center.

Category	Item	Input-length
Crestron Control	IP Address	15
	IP ID	3
	Port	5
Projector	Projector Name	25
	Location	25
	Assigned To	25
Network Configuration	DHCP (Enabled)	(N/A)
	IP Address	15
	Subnet Mask	15
	Default Gateway	15
	DNS Server	15
User Password	Enabled	(N/A)
	New Password	10
	Confirm	10
Admin Password	Enabled	(N/A)
	New Password	10
	Confirm	10

For more information, please visit <http://www.crestron.com>.

OSD description

Preparing email alerts

1. Make sure that user can access the homepage of LAN RJ45 function by web browser (for example, Microsoft Internet Explorer 11).
2. From the homepage of LAN/RJ45, click **Alert Settings**.

Projector Info	Model Name	
Alert Mail Settings	System	
Crestron	System Status	Power On
	Display Source	BNC
	Laser Hours	2
	Display Mode	Presentation
	Error Status	No Error
	LAN Status	
	IP address	10.10.10.10
	Subnet mask	255.255.255.0
	Default gateway	0.0.0.0
	DNS Server	0.0.0.0
	MAC address	00:18:23:50:FF:02
	Version	
	LAN Version	MHD02_UL
	F/W Version	E05

3. By default, these input boxes in **Alert Settings** are blank.

Projector Info	Send E-Mail
Alert Mail Settings	Enter the appropriate settings in the fields below: (Your SMTP server may not require a user name or password.)
Crestron	

SMTP Server: **Port:**

User Name:

Password:

From:

To:

CC:

E-mail Alert Options:

<input checked="" type="checkbox"/> Fan Lock :	<input checked="" type="checkbox"/> Over_Heat:
<input checked="" type="checkbox"/> Case Open:	<input checked="" type="checkbox"/> Laser Fail:
<input checked="" type="checkbox"/> Other Error:	<input checked="" type="checkbox"/> Laser Hours Over:

4. For Sending alert mail, input the following:

The SMTP field is the mail server for sending out email (SMTP protocol). This is a required field.

The To field is the recipient’s email address (for example, the projector administrator). This is a required field.

The Cc field sends a carbon copy of the alert to the specified email address. This is an optional field (for example, the projector administrator’s assistant).

The From field is the sender’s email address (for example, the projector administrator). This is a required field.

Select the alert conditions by checking the desired boxes.

Note: Fill in all fields as specified. User can click Send Test Mail to test what setting is correct. For successful sending an e-mail alert, you must select alert conditions and enter a correct e-mail address.

RS232 by telnet function

Besides projector connected to RS232 interface with “Hyper-Terminal” communication by dedicated RS232 command control, there is alternative RS232 command control way, so called “RS232 by TELNET” for LAN/RJ45 interface.

Specsheet for “RS232 by TELNET”:

1. Telnet: TCP
2. Telnet port: 23

(for more detail, kindly please get contact with the service agent or team)

OSD description

- **HDBaseT/IR**

Press **ENTER** / ► to enter the **HDBaseT/IR** menu.

- **HDBaseT– IR/RS232/RJ45**

Press ◀► to enter and enable or disable HDBaseT–IR/RS232/RJ45 Control.

- **Front IR**

Press ◀► to enter and enable or disable Front IR.

- **Rear IR**

Press ◀► to enter and enable or disable Rear IR.

*Note: Enable **HDBaseT– IR/RS232/RJ45 control** function when you desire to use **HDBaseT TX** box. (Remove **RS232** and **RJ45/LAN** control function from Projector to **HDBaseT TX** box.) See **HDBaseT– IR/RS232/RJ45 control** function table.*

*Note: When **HDBaseT– IR/RS232/RJ45** enable, **Low Power Mode** will auto set to **HDBaseT**.*

*Note: **HDBaseT– IR/RS232/RJ45** control is disabled when the **HDBaseT TX** box signal is cutoff.*

HDBaseT– IR/RS232/RJ45 control function table

Control Side	Function	Projector Mode			Remark
		Low Power Mode On (<0.5W)	Low Power Mode On by Lan (<3W)	HDBaseT control Enable Low Power Mode On by HDBaseT (<6W)	
Projector	Front-IR (wireless)	O	O	O (Can disable by OSD)	
	Rear-IR (wireless)	O	O	O (Can disable by OSD)	
	RS-232	O	O	X	
	RJ45/LAN	X	O	X	
HDBaseT TX Box	HDBT-IR (wireless)	X	X	O	
	RS-232	X	X	O	
	RJ45/LAN	X	X	O	
	Wired remote	X	X	O	User can connect wired remote at HDBaseT TX side to get the wired function.

O: Enable X: Disable

Advanced 2

Press **ENTER** / ► to enter the **Advanced 2** menu.

- **Sleep Timer**

Press ◀► to enter and set sleep timer. The projector automatically turns off after the preset period of time.

- **Source Filter**

Press **ENTER** / ► to enter the **Source Filter** menu.

Press ◀► to enter and enable or disable the desire source.

Custom Light

In Custom Light mode press ◀► to enter and adjust the brightness of the projectors to similarity.

*Note: When **Laser Mode** set to **Custom Light**, **Custom Light** function Enable.*

Cleaning

Turn off the projector and unplug the power before cleaning. Suggest to wait at least 45 minute to let the projector cool down.

Cleaning the cabinet

- Use a dry soft cloth to wipe off the cabinet dust.
Note: Not suggest to use cleanser. If too dirty, only use little neutral detergent to clean the cabinet.
- Use a vacuum cleaner to clean the cabinet.
Note: Poor ventilation causes overheat and reducing the life of the laser module.
Note: Need to clean the interior of machine, please contact your dealer.

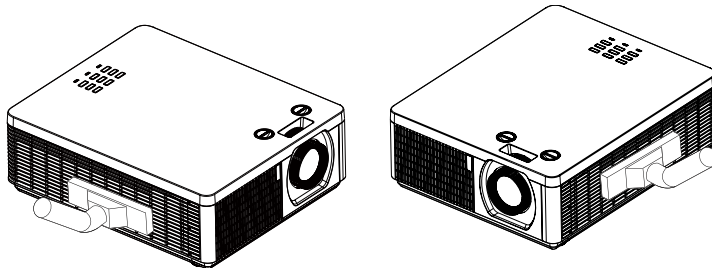

Cleaning the lens

- Cleaning tool should include soft fur air brush, lens cleaning paper, lens cleaning fluid, soft cloth.
Note: You can buy these items from the Camera stores.
- Use soft fur air brush to blow off dust on the lens surface. Then gently brush the surface dust.
Note: The action should be gentle.
- Fold the lens cleaning paper and add few drops of cleaning liquid on paper, follow the clockwise or counterclockwise direction to wipe lightly from center to outside.
Note: Cleaning liquid can't be added directly to the lens surface.
To avoide scratch the lens, do not wipe straightly back and forth.
- After the lens cleaning fluid a little dry. Get a new clean cleaning paper and using the same method to clean the lens.
- Finally, wipe the lens with a soft cloth.
Note: Not every time need to use the above method to clean the lens in the case that the lens has a difficulty to remove soiled place.

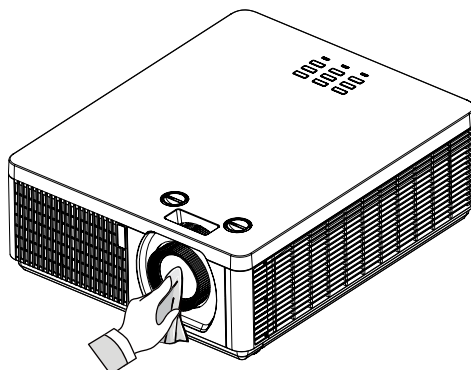

Using the Kensington® lock

Using the Kensington® lock

Worry about the security of the projector. You can use Kensington lock the projector to avoid it be stolen.

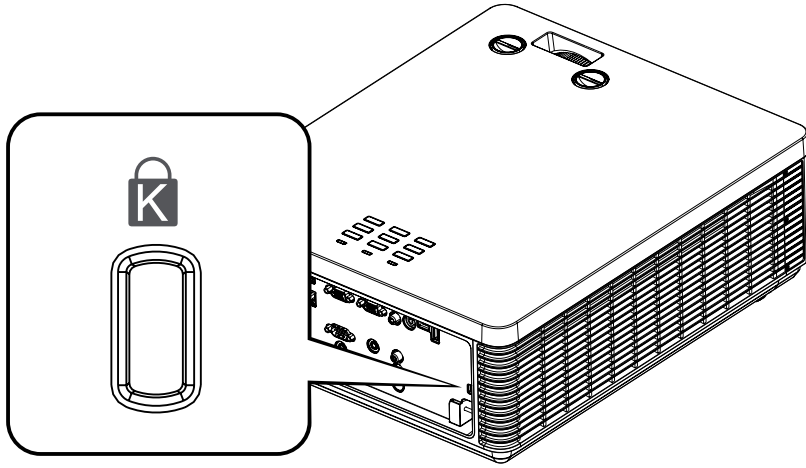

Note: For Kensington lock detail installation information. Please contact to the dealer.

Simple troubleshooting

The following table offers a list of common problems with projectors and how to troubleshoot. If the recommended solutions fail to resolve your problem, contact your local dealer to arrange for servicing; do not attempt to service the projector by yourself.

Problem	Possible cause	Solution
You cannot turn on the projector.	<ol style="list-style-type: none"> 1. The projector may be unplugged. 2. The AC socket may be faulty. 3. The lens is not attached. 	<ol style="list-style-type: none"> 1. Plug the projector's power cord into a wall outlet. 2. Make sure the AC socket is working properly. 3. Mount the lens.
The remote control does not operate normally.	<ol style="list-style-type: none"> 1. The battery might have run out. 2. You might have inserted the batteries in the wrong orientations. 3. You may be operating the remote control too far away from the projector's IR sensor or exceeded the maximum angle of signal reception ; there might be an obstacle between the projector and the remote control. Possibility interference of fluorescent light or direct sunlight. 4. Ø 3.5mm A wired remote connector might be connected to the projector's 3.5mm port. 5. The remote control's address is not consistent with the projector's address. 6. Remote control is disabled by OSD menu. 	<ol style="list-style-type: none"> 1. Replace new batteries. 2. Make sure the batteries are inserted in the right orientation. 3. Adjust the distance/angle between the projector and the remote control and try again; if there are obstacles between the projector and the remote or source of intense light near the IR sensor resolve these situations and try again. 4. Remove the wired remote cable or operate the projector using wired remote. 5. Refer to Page 62 : "Remote ID" for detail information. 6. Refer to MENU → Settings 2 → Advanced → Front IR or Rear IR for detail information.
You are able to turn on the projector and access the OSD Menu but no picture appears.	<ol style="list-style-type: none"> 1. The projector may not be turned on properly or you have not selected the correct input source. 2. You might not have connected the source device correctly or the source might not be connected to the projector at all. 3. Auto blank function maybe available because of no signal input. 4. Blank function maybe available. 	<ol style="list-style-type: none"> 1. Make sure the projector is turned on properly and select the correct input source. 2. Check the connection between the projector and the input device. 3. Select input source or connect the source device. 4. Press BLANK on the remote control.
You can turn on the projector. But projector display nothing on screen.	No image on screen. Only the sound of the machine operation.	Press BLANK of the remote control.
You have connected the projector to a DVD player as the input source but the picture appears broken.	The DVD player is connected to the projector through component cables and you have set it to progressive scan.	Disable the progress scanning function on the DVD player.
The picture looks dim.	<ol style="list-style-type: none"> 1. The picture brightness, contrast, color and tint might need proper adjustment. 2. The Laser Mode setting Extreme Dimming mode 	<ol style="list-style-type: none"> 1. Adjust the picture brightness, contrast, color and tint. 2. Refer to Page 60 : "Laser Mode" to adjust the Laser mode.
The picture is too bright or the bright areas are blurry.	The contrast might have been set too high.	Lower contrast settings.
The picture appears washed out or the dark areas appear too bright.	The picture brightness might have been set too high.	Lower brightness settings.
The picture is blurry.	<ol style="list-style-type: none"> 1. The lens may not be in focus. 2. The temperature or humidity of the projector's working environment may have changed in mid operation (i.e. going from cold to warm or dry to humid), leading to condensation of moisture inside the projector. 	<ol style="list-style-type: none"> 1. Adjust lens focus. 2. Turn of the projector first and wait for the moisture in the projector to evaporate.

Simple troubleshooting

Problem	Possible cause	Solution
The color of the picture looks pale.	<ol style="list-style-type: none"> 1. The input signal type might not have been connected properly. 2. The Color is not correct setting. 	<ol style="list-style-type: none"> 1. Check to make sure that the connections between the projector and the input device are correct. 2. Press Menu to adjust the color related setting.
The picture flashes occasionally.	<ol style="list-style-type: none"> 1. The cables might not have been properly connected or the input device itself may be faulty. 	<ol style="list-style-type: none"> 1. Make sure the connector and the input device have been properly connected; check to see if the input device is in normal working order.
The colors of the projected picture are out of place (i.e. displaying red as blue).	The G/Y, R/Pr, B/Pb cables from the input might have been incorrectly connected to the input.	Please make sure the input source has been correctly connected to the projector.
The noise from the cooling fan suddenly grew louder.	<ol style="list-style-type: none"> 1. The temperature inside the projector might have risen. 2. The OSD menu set the High mode 	<ol style="list-style-type: none"> 1. When the temperature inside the projector rises, the cooling fan will operate at a higher speed to discharge the internal heat more rapidly. 2. Set the Fan Speed to Normal if the projector is under 1520 meters (5000 feet). Refer to Page 62 and Page 76..
The LED indicator on the projector's top panel is blinking in red.	The cooling fan, power....etc. could be faulty.	Refer to the definition of Page 74 : "LED status".
<ol style="list-style-type: none"> 1. During projection, the light suddenly goes off and the picture disappears. 2. The lights does not turn on even when the projector has been turned on. 	The light module might have been damaged; check the LED indicator on the front of the projector and see if it is blinking in red.	The light module has reached the end of its service life; please replace it.

LED status

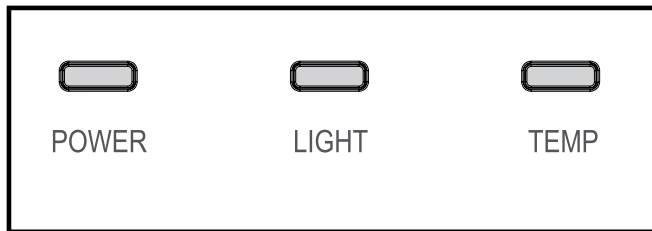

Error	LED		
	Power	Light	Temp
SYS_ERR_NO_ERROR	Fix	-	-
SYS_ERR_THBREAK	4	-	-
SYS_ERR_G7932	4	2	-
SYS_ERR_ADS1015	4	7	-
SYS_ERR_TMP100	4	8	-
SYS_ERR_DRIVERBOARD_Comm_Fail	8	1	-
SYS_ERR_DRIVERBOARD_Speed_CW	8	2	-
SYS_ERR_DRIVERBOARD_Speed_PW	8	3	-
SYS_ERR_DRIVERBOARD_54V	8	4	-
SYS_ERR_DRIVERBOARD_Temp	8	5	-
SYS_ERR_DRIVERBOARD_SCI	8	6	-

Error	LED		
	Power	Light	Temp
SYS_ERR_FAN1LOCK	6	1	-
SYS_ERR_FAN2LOCK	6	2	-
SYS_ERR_FAN3LOCK	6	3	-
SYS_ERR_FAN4LOCK	6	4	-
SYS_ERR_FAN5LOCK	6	5	-
SYS_ERR_FAN6LOCK	6	6	-
SYS_ERR_FAN7LOCK	6	7	-
SYS_ERR_FAN8LOCK	6	8	-
SYS_ERR_CASEOPEN	7	-	-
SYS_ERR_DAD	8	-	-
SYS_ERR_CWSPIN	9	-	-
SYS_ERR_PWSPIN	9	1	-
SYS_ERR_OVERTEMP_T1	-	1	Fix
SYS_ERR_I2C_T1	-	1	Fix
SYS_ERR_OPEN_T1	-	1	Fix
SYS_ERR_OVERTEMP_T2	-	2	Fix
SYS_ERR_I2C_T2	-	2	Fix
SYS_ERR_OPEN_T2	-	2	Fix
SYS_ERR_OVERTEMP_T3	-	3	Fix
SYS_ERR_I2C_T3	-	3	Fix
SYS_ERR_OPEN_T3	-	3	Fix
SYS_ERR_OVERTEMP_T4	-	4	Fix
SYS_ERR_I2C_T4	-	4	Fix
SYS_ERR_OPEN_T4	-	4	Fix
SYS_ERR_OVERTEMP_T5	-	5	Fix
SYS_ERR_I2C_T5	-	5	Fix
SYS_ERR_OPEN_T5	-	5	Fix
SYS_WARNING_LASER_LIFE	-	Fix	-

Specifications

Specifications

Specifications

Description	Specifications
Model Name	8965WUSS
Resolution	1920 × 1200 (Native)
Micro display	1 x 0.67" WUXGA DMD
Light	Laser Diode: 4 Banks Green and Red by laser phosphor Blue by diffuse laser
Input/Output ports	1 x COMPUTER IN (D-SUB) 1 x RS-232 1 x HDBaseT 1 x RJ45 (10/100 Mbps) 1 x USB Power 1 x 3D Sync 1 x Video 1 x Service 1 x Audio In (L/R) 1 x Audio In 2 x HDMI 1 x HDMI/MHL 1 x Monitor Out 1 x Audio Out (3.5mm, mini jack)
Power supply/Rated current	100V - 240V: 5A
Power consumption	100V - 240V: 500W
Standby power consumption	0.5W max power when Low Power Mode setting is "ON"
Maximum input resolution	1920 × 1200
Operating temperature and humidity	0~40°C(32~104°F), 10~85% (No condensing)
Altitude temperature	0~1520m (0~5000 feet): 0~40°C (32~104°F) Note: >35°C:brightness 60% 1520~3050m (5000~10000 feet): 0~40°C (32~104°F) Note: >25°C:brightness 60%
Storage temperature and humidity	-20°C~60°C(-4°F~140°F), 5%~95% RH (No condensation)
Weight	Approximately 11.4 kg

Supported signal input modes

Signal Format	Resolution	H Freq. KHz	Frame Rate Hz	PCLK MHz	Component VGA	VGA - RGBHV	HDMI / HDBaseT			Remark
							RGB	YUV		
								8bit	10bit	
PC	640 x 480	31.469	59.94	25.175		X	X			VESA DMT
		37.500	74.99	31.500		X	X			VESA DMT
	640 x 480	37.684	74.77	30.750		X	X			VESA CVT
		37.650	75.00	30.722		X	X			VESA GTF
	640 x 480	43.269	85.00	36.000		X	X			VESA DMT
		42.892	84.60	35.000		X	X			VESA CVT
		42.925	85.00	35.714		X	X			VESA GTF
	800 x 600	37.879	60.32	40.000		X	X			VESA DMT
		37.354	59.86	38.250		X	X			VESA CVT
		37.320	60.00	38.216			X			VESA GTF
	800 x 600	46.875	75.00	49.500		X	X			VESA DMT
		47.115	74.91	49.000		X	X			VESA CVT
		47.025	75.00	48.906			X			VESA GTF
	800 x 600	53.674	85.06	56.250		X	X			VESA DMT
		53.741	84.90	56.750		X	X			VESA CVT
		53.550	85.00	56.549			X			VESA GTF
	848 x 480	23.674	47.95	25.000		X	X			VESA CVT
		31.020	60.00	33.750		X	X			VESA DMT
	848 x 480	29.830	59.66	31.500		X	X			VESA CVT
		29.820	60.00	31.490			X			VESA GTF
		48.363	60.00	65.000		X	X			VESA DMT
	1024 x 768	47.816	59.92	63.500		X	X			VESA CVT
		47.700	60.00	64.109		X	X			VESA GTF
		60.023	75.00	78.750		X	X			VESA DMT
	1024 x 768	60.294	74.90	82.000		X	X			VESA CVT
		60.150	75.00	81.804		X	X			VESA GTF
	1024 x 768	68.677	85.00	94.500	"	X	X			VESA DMT
		68.677	84.89	94.500		X	X			VESA CVT
		68.595	85.00	94.387		X	X			VESA GTF
	1280x720	35.531	47.95	57.987						VESA GTF
	1280x1024	63.981	60.02	108.000		X	X			VESA DMT
		63.668	59.89	109.000		X	X			VESA CVT
		63.600	60.00	108.883		X	X			VESA GTF
	1280x1024	79.976	75.02	135.000		X	X			VESA DMT
		80.295	74.90	138.750		X	X			VESA CVT
		80.175	75.00	138.542		X	X			VESA GTF
	1280x1024	91.146	85.02	157.500		X	X			VESA DMT
		91.456	84.84	159.500		X	X			VESA CVT
		91.375	85.00	159.358		X	X			VESA GTF
	1600x1200	75.000	60.00	162.000		X	X			VESA DMT
74.537		59.87	161.000		X	X			VESA CVT	
1920x1080	74.520	60.00	160.963		X	X			VESA GTF	
1920x1080	53.225	47.95	135.403						VESA CVT	
1680x1050	65.290	60.00	146.250		X	X			VESA DMT	
	65.290	59.95	146.250		X	X			VESA CVT	
	65.220	60.00	147.136		X	X			VESA GTF	
1920x1200	61.816	50.00	158.250		X	X			VESA CVT	
1920x1200	74.038	60.00	154.000		X	X			VESA CVT	
1400X1050	65.317	60.00	121.750		X	X			VESA DMT	
	65.317	59.98	121.750		X	X			VESA CVT	
	65.220	60.00	122.614		X	X			VESA GTF	

Specifications

Signal Format	Resolution	H Freq. KHz	Frame Rate Hz	PCLK MHZ	Component VGA	VGA - RGBHV	HDMI / HDBaseT			Remark	
							RGB	YUV			
								8bit	10bit		12bit
PC	1366 x 768	47.712	60.00	85.500		X	X			VESA DMT	
	1440 x 900	55.935	60.00	106.500		X	X			VESA DMT	
		55.935	59.89	106.500						VESA CVT	
		55.920	60.00	106.472		X	X			VESA GTF	
		47.776	60.00	79.500		X	X			VESA DMT	
	1280 x 768	47.776	59.87	79.500		X	X			VESA CVT	
		47.700	60.00	80.136		X	X			VESA GTF	
		49.702	60.00	83.500		X	X			VESA DMT	
	1280 x 800	49.702	59.81	83.500						VESA CVT	
		49.680	60.00	83.462		X	X			VESA GTF	
		60.000	60.00	108.000		X	X			VESA DMT	
	1280 x 960	59.699	59.94	101.250		X	X			VESA CVT	
		59.640	60.00	102.104			X			VESA GTF	
		37.071	49.83	60.500		X	X			VESA CVT	
	1280x720	37.050	50.00	60.466		X	X			VESA GTF	
		44.772	59.86	74.500		X	X			VESA CVT	
		44.760	60.00	74.481		X	X			VESA GTF	
		55.621	49.93	141.500		X	X			VESA CVT	
	1920x1080	37.050	50.00	60.466						VESA GTF	
		44.760	60.00	74.481						VESA GTF	
	1600 x 900	55.990	59.95	118.250		X	X			VESA CVT	
		55.920	60.00	118.998		X	X			VESA GTF	
	1600 x 900(RB)	60.000	60.00	108.000		X	X			VESA DMT	
		55.540	59.98	97.750		X	X			VESA CVT	
	1360 x 768	47.720	59.80	84.750		X	X			VESA CVT	
		47.700	60.00	84.715		X	X			VESA GTF	
	Apple Mac	640x480	35.000	66.67	30.240		X	X			Apple MAC
		832x624	49.720	74.54	57.280		X	X			Apple MAC
SDTV	480i	15.734	59.94	13.500	X						
	1440x480i	31.468	60.00	27.000			X	X	X	X	
	1440x576i	31.250	50.00	27.000			X	X	X	X	
EDTV	576i	15.625	50.00	13.500	X						
	480p	31.469	59.94	27.000	X	X	X	X	X	X	
HDTV	576p	31.250	50.00	27.000	X	X	X	X	X	X	
	1080i	28.125	50.00	74.250	X	X	X	X	X	X	
	1080i	33.716	59.94	74.176	X	X	X	X	X	X	
	1080i	33.750	60.00	74.250	X	X	X	X	X	X	
	720p	37.500	50.00	74.250	X	X	X	X	X	X	
	720p	44.955	59.94	74.176	X	X	X	X	X	X	
	720p	45.000	60.00	74.250	X	X	X	X	X	X	
	1080p	26.973	23.98	74.176	X	X	X	X	X	X	
	1080p	27.000	24.00	74.250	X	X	X	X	X	X	
	1080p	28.125	25.00	74.250	X	X	X	X	X	X	
	1080p	33.716	29.97	74.176	X	X	X	X	X	X	
	1080p	33.750	30.00	74.250	X	X	X	X	X	X	
	1080p	56.250	50.00	148.500	X	X	X	X	X	X	
	1080p	67.433	59.94	148.352	X	X	X	X	X	X	
	1080p	67.5	60.00	148.500	X	X	X	X	X	X	

MHL timing format

Mode	V-Freq (KHz)	Frame Rate (Hz)	Pixel Clock (MHz)
720x480P 60	31.469	59.94	27.000
720x576P 50	31.250	50	27.000
720(1440)x480i 60	15.734	59.94	27.000
720(1440)x576i 50	15.625	50	27.000
1280x720P 60	44.955	59.94	74.175
1920x1080i 60	33.716	59.94	74.175
1920x1080i 50	28.125	50	74.250
1920x1080P 30	33.750	30	74.250
1920x1080P 60	67.432	59.94	148.350 (#1)
1920x1080P 50	56.250	50	148.500 (#1)

3D timing format

Standard	Resolution	V-Freq (Hz)	V-Total	H-Freq (kHz)	HDMI1/2/3 (*1)	HDBaseT (*1)	Remarks
720p50 Frame Packing	1280x720	50	1470	37.5	X	X	
720P60 Frame Packing	1280x720	60	1470	45	X	X	
1080P23 Frame Packing	1920x1080	23.98	2205	27	X	X	
1080P24 Frame Packing	1920x1080	24	2205	27	X	X	
1080i50 Side-by-Side (Half)	1920x1080	50	1125	56	X	X	
1080i59 Side-by-Side (Half)	1920x1080	60	1125	67	X	X	
1080i60 Side-by-Side (Half)	1920x1080	60	1125	68	X	X	
1080p50 Side-by-Side (Half)	1920x1080	50	1125	56	X	X	
1080p59 Side-by-Side (Half)	1920x1080	60	1125	67	X	X	
1080p60 Side-by-Side (Half)	1920x1080	60	1125	68	X	X	
720p50 Top-and-Bottom	1280x720	50	750	38	X	X	
720p59 Top-and-Bottom	1280x720	60	750	45	X	X	
720p60 Top-and-Bottom	1280x720	60	750	45	X	X	
1080p50 Top-and-Bottom	1920x1080	50	1125	56	X	X	
1080p59 Top-and-Bottom	1920x1080	60	1125	67	X	X	
1080p60 Top-and-Bottom	1920x1080	60	1125	68	X	X	
1080p50 Frame Sequential	1920x1080	50	1125	56	X	X	
1080p59 Frame Sequential	1920x1080	60	1125	67	X	X	
1080p60 Frame Sequential	1920x1080	60	1125	68	X	X	

*1: Base on IT6802 chip specification

Specifications

Dimensions

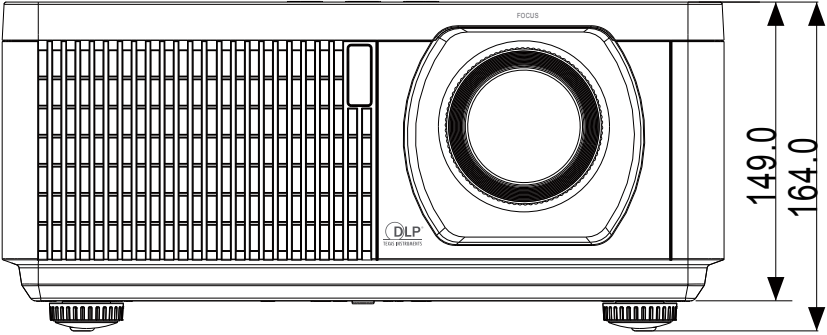
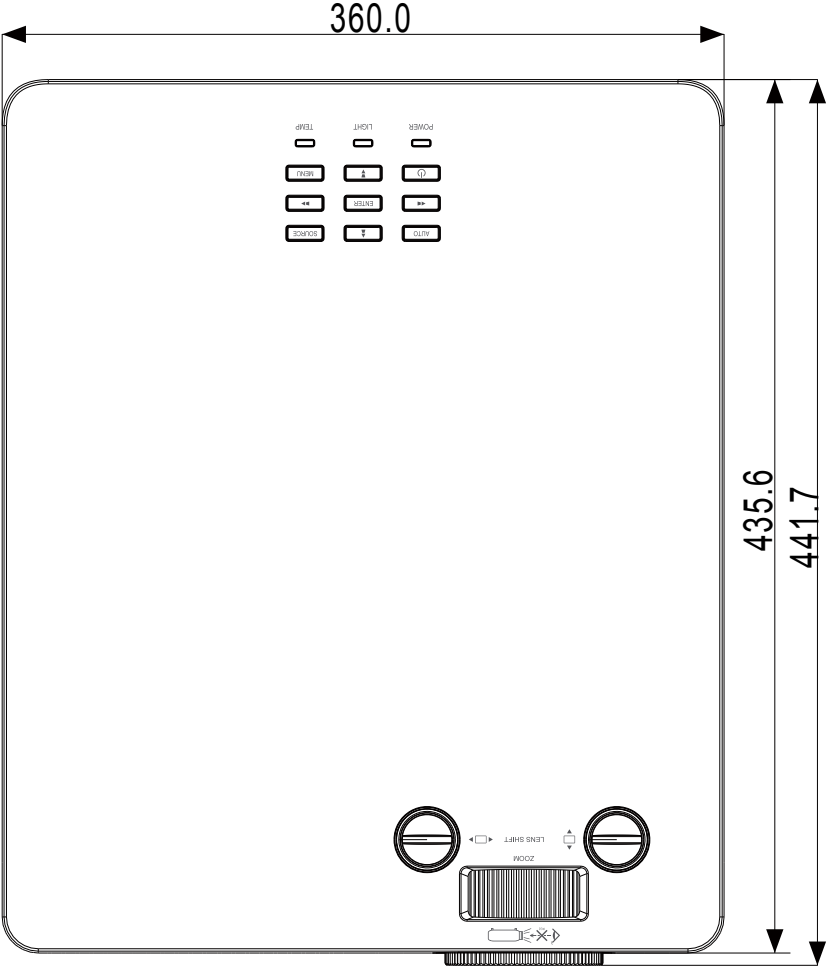

Communication settings

RS-232 communication

When the projector connects to the computer by RS-232 communication, the projector can be controlled with RS-232 commands from the computer. For details of RS-232 commands, refer to RS-232 Communication command table.

Connection

1. Turn off the projector and the computer.
2. Connect the projector's RS-232 port and the computer's RS-232 port with a RS-232 cable (crossover) . Use the cable that fulfills the specification shown in the figure
3. Turn the computer on, and after the computer has started up turn the projector on.

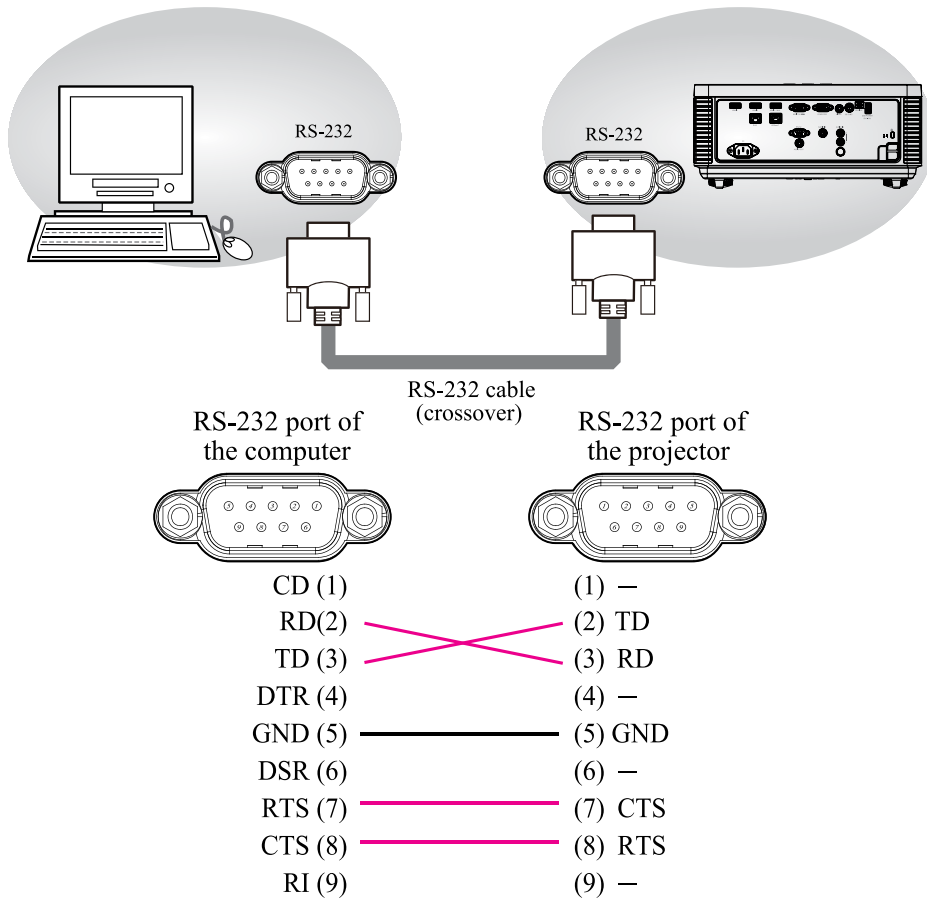

Note: In case of replacement and RS-232 cable (straight) has been installed, please add a packed RS-232 cable (cross) to make connection correctly.

Communication settings

1. Protocol

19200bps,8N1

2. Command format

("h" shows hexadecimal)

Byte Number	0	1	2	3	4	5	6	7	8	9	10	11	12
Command Action	Header						Data						
	Header code		Packet	Data size		CRC flag		Action		Type		Setting code	
	L	H		L	H	L	H	L	H	L	H	L	H
<SET> Change setting to desired value [(cL)(cH)] by [(bL)(bH)].						(aL)	(aH)	01h	00h	(bL)	(bH)	(cL)	(cH)
<GET> Read projector internal setup value [(bL)(bH)].						(aL)	(aH)	02h	00h	(bL)	(bH)	00h	00h
<INCREMENT> Increment setup value [(bL)(bH)] by 1.	BEh	EFh	03h	06h	00h	(aL)	(aH)	04h	00h	(bL)	(bH)	00h	00h
<DECREMENT> Decrement setup value [(bL)(bH)] by 1.						(aL)	(aH)	05h	00h	(bL)	(bH)	00h	00h
<EXECUTE> Run a command [(bL)(bH)].						(aL)	(aH)	06h	00h	(bL)	(bH)	00h	00h

[Header code] [Packet] [Data size]

Set [BEh, EFh, 03h, 06h, 00h] to byte number 0~4.

[CRC flag]

For byte number 5, 6, refer to RS-232 Communication command table.

[Action]

Set functional code to byte number 7, 8.

<SET> = [01h, 00h], <GET> = [02h, 00h], <INCREMENT> = [04h, 00h]

<DECREMENT> = [05h, 00h], <EXECUTE> = [06h, 00h]

Refer to RS232 Communication command table

[Type] [Setting code]

For byte number 9~12, refer to RS-232 Communication command table.

3. Response code / Error code

("h" shows hexadecimal)

1. ACK reply: 06h

When the projector receives the Set, Increment, Decrement or Execute, command correctly, the projector changes the setting data for the specified, item by [Type], and it returns the code.

2. NAK reply: 15h

When the projector cannot understand the received command, the projector, returns the error code. In such a case, check the sending code and send the same command again.

3. Error reply: 1Ch + 0000h

When the projector cannot execute the received command for any reasons, the projector returns the error code. In such a case, check the sending code and the setting status of the projector.

4. Data reply: 1Dh + xxxxh

When the projector receives the GET command correctly, the projector returns the response code and 2 bytes of data.

Note: For connecting the projector to your devices, please read the manual for each device, and connect them correctly with suitable cables.

Note: Operation cannot be guaranteed when the projector receives an undefined command or data.

Note: Provide an interval of at least 40ms between the response code and any other code.

Note: The projector outputs test data when the power supply is switched ON, and when the light is lit. Ignore this data.

Note: Commands are not accepted during warm-up.

Note: When the data length is greater than indicated by the data length code, the projector ignore the excess data code. Conversely when the data length is shorter than indicated by the data length code, the projector returns the error code to the computer.

Command control via the network

When the projector connects network, the projector can be controlled with RS-232C commands from the computer with web browser.

For details of RS-232C commands, refer to RS-232C Communication / Network command table.

Connection

1. Turn off the projector and the computer.
2. If you use wired LAN, connect the projector's RJ45 port to the computer's LAN or HDBaseT port with a LAN cable. Use the cable that fulfills the specification shown in figure.
3. Turn the computer on, and after the computer has started up turn the projector on.

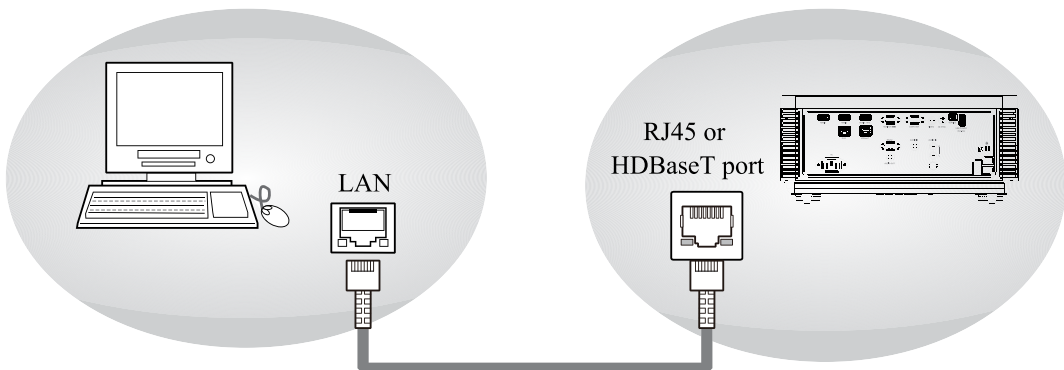

- LAN cable (CAT-5e or greater)
- or
- For HDBaseT connection
 - CAT-5e or greater
 - shielded type (connectors included)
 - straight cable
 - single cable

Communication port

The following two ports are assigned for the command control.

TCP #23

Communication settings

Command control settings

[TCP #23]

1. Command format

Same as RS-232C communication, refer to RS-232C Communication command format.

2. Response code / Error code (“h” shows hexadecimal)

Four of the response / error code used for TCP#23 are the same as RS-232C Communication (1)~(4).

(1) ACK reply: 06h

Refer to RS-232C communication.

(2) NAK reply: 15h

Refer to RS-232C communication.

(3) Error reply: 1Ch + 0000h

Refer to RS-232C communication.

(4) Data reply: 1Dh + xxxxh

Refer to RS-232C communication.

Note: Operation cannot be guaranteed when the projector receives an undefined command or data.

Note: Provide an interval of at least 40ms between the response code and any other code.

Note: Commands are not accepted during warm-up.

Communication command table

Function	Operation		Header Data (7 bytes)				Command Data (6 bytes)			Description
			Header Code	Packet	Data Size	CRC	Action	Type	Setting Code	
Picture Mode	Set	Presentation	BE EF	03	06 00	B3 CB	01 00	BA 30	51 00	
		High Bright	BE EF	03	06 00	23 CA	01 00	BA 30	50 00	
		Sports	BE EF	03	06 00	D3 F6	01 00	BA 30	03 00	
		Cinema	BE EF	03	06 00	B3 F7	01 00	BA 30	01 00	
		Photo	BE EF	03	06 00	73 F5	01 00	BA 30	05 00	
		Video	BE EF	03	06 00	43 CB	01 00	BA 30	52 00	
		Natural	BE EF	03	06 00	23 F6	01 00	BA 30	00 00	
		DICOM SIM.	BE EF	03	06 00	73 C6	01 00	BA 30	41 00	
		USER-1	BE EF	03	06 00	E3 FB	01 00	BA 30	10 00	
	USER-2	BE EF	03	06 00	73 FA	01 00	BA 30	11 00		
	Get		BE EF	03	06 00	10 F6	02 00	BA 30	00 00	
Brightness	Set	0 - 100	BE EF	03	06 00	[*1]	01 00	03 20	[*2]	[*1]: CRC (Low, High) [*2]: 00 00 (Min) - 64 00 (Max)
		Increment	BE EF	03	06 00	EF D2	04 00	03 20	00 00	
		Decrement	BE EF	03	06 00	3E D3	05 00	03 20	00 00	
		Get	BE EF	03	06 00	89 D2	02 00	03 20	00 00	
Contrast	Set	0 - 100	BE EF	03	06 00	[*1]	01 00	04 20	[*2]	[*1]: CRC (Low, High) [*2]: 00 00 (Min) - 64 00 (Max)
		Increment	BE EF	03	06 00	9B D3	04 00	04 20	00 00	
		Decrement	BE EF	03	06 00	4A D2	05 00	04 20	00 00	
		Get	BE EF	03	06 00	FD D3	02 00	04 20	00 00	
H Position	Set	0 - 10	BE EF	03	06 00	[*1]	01 00	01 21	[*2]	[*1]: CRC (Low, High) [*2]: 00 00 (Min) - 0A 00 (Max)
		Increment	BE EF	03	06 00	97 82	04 00	01 21	00 00	
		Decrement	BE EF	03	06 00	46 83	05 00	01 21	00 00	
		Get	BE EF	03	06 00	F1 82	02 00	01 21	00 00	

Communication settings

Function	Operation		Header Data (7 bytes)				Command Data (6 bytes)			Description
			Header Code	Packet	Data Size	CRC	Action	Type	Setting Code	
V Position	Set	0 - 10	BE EF	03	06 00	[*1]	01 00	00 21	[*2]	[*1]: CRC (Low, High) [*2]: 00 00 (Min) - 0A 00 (Max)
	Increment		BE EF	03	06 00	6B 83	04 00	00 21	00 00	
	Decrement		BE EF	03	06 00	BA 82	05 00	00 21	00 00	
	Get		BE EF	03	06 00	0D 83	02 00	00 21	00 00	
H Phase	Set	0 - 31	BE EF	03	06 00	[*1]	01 00	03 21	[*2]	[*1]: CRC (Low, High) [*2]: 00 00 (Min) - 1F 00 (Max)
	Increment		BE EF	03	06 00	2F 83	04 00	03 21	00 00	
	Decrement		BE EF	03	06 00	FE 82	05 00	03 21	00 00	
	Get		BE EF	03	06 00	49 83	02 00	03 21	00 00	
H Size	Set	0 - 10	BE EF	03	06 00	[*1]	01 00	02 21	[*2]	[*1]: CRC (Low, High) [*2]: 00 00 (Min) - 0A 00 (Max)
	Increment		BE EF	03	06 00	D3 82	04 00	02 21	00 00	
	Decrement		BE EF	03	06 00	02 83	05 00	02 21	00 00	
	Get		BE EF	03	06 00	B5 82	02 00	02 21	00 00	
Auto Adjust	Execute		BE EF	03	06 00	91 D0	06 00	0A 20	00 00	
Brilliant Color	Set	0 - 10	BE EF	03	06 00	[*1]	01 00	9C 22	[*2]	[*1]: CRC (Low, High) [*2]: 00 00 (Min) - C8 00 (Max)
	Increment		BE EF	03	06 00	3B 5D	04 00	9C 22	00 00	
	Decrement		BE EF	03	06 00	EA 5C	05 00	9C 22	00 00	
	Get		BE EF	03	06 00	5D 5D	02 00	9C 22	00 00	
Sharpness	Set	0 - 31	BE EF	03	06 00	[*1]	01 00	01 22	[*2]	[*1]: CRC (Low, High) [*2]: 00 00 (Min) - 1F 00 (Max)
	Increment		BE EF	03	06 00	97 72	04 00	01 22	00 00	
	Decrement		BE EF	03	06 00	46 73	05 00	01 22	00 00	
	Get		BE EF	03	06 00	F1 72	02 00	01 22	00 00	
Gamma	Set	1.8	BE EF	03	06 00	3B 86	01 00	A0 30	B4 00	
		2.0	BE EF	03	06 00	FB A6	01 00	A0 30	C8 00	
		2.2	BE EF	03	06 00	FB A9	01 00	A0 30	DC 00	
		2.4	BE EF	03	06 00	3B B5	01 00	A0 30	F0 00	
		B&W	BE EF	03	06 00	EB F1	01 00	A0 30	FD FF	
		Linear	BE EF	03	06 00	1B F1	01 00	A0 30	FE FF	
	Get	BE EF	03	06 00	08 F1	02 00	A0 30	00 00		
Color Temperature	Set	Low	BE EF	03	06 00	6B F4	01 00	B0 30	01 00	
		Mid-1	BE EF	03	06 00	9B F4	01 00	B0 30	02 00	
		High	BE EF	03	06 00	0B F5	01 00	B0 30	03 00	
	Get	BE EF	03	06 00	C8 F5	02 00	B0 30	00 00		
Video AGC	Set	Off	BE EF	03	06 00	92 5C	01 00	9D 22	00 00	
		On	BE EF	03	06 00	02 5D	01 00	9D 22	01 00	
	Get	BE EF	03	06 00	A1 5C	02 00	9D 22	00 00		
Color	Set	0 - 100	BE EF	03	06 00	[*1]	01 00	02 22	[*2]	[*1]: CRC (Low, High) [*2]: 00 00 (Min) - 64 00 (Max)
	Increment		BE EF	03	06 00	D3 72	04 00	02 22	00 00	
	Decrement		BE EF	03	06 00	02 73	05 00	02 22	00 00	
	Get		BE EF	03	06 00	B5 72	02 00	02 22	00 00	
Tint	Set	0 - 100	BE EF	03	06 00	[*1]	01 00	03 22	[*2]	[*1]: CRC (Low, High) [*2]: 00 00 (Min) - 64 00 (Max)
	Increment		BE EF	03	06 00	2F 73	04 00	03 22	00 00	
	Decrement		BE EF	03	06 00	FE 72	05 00	03 22	00 00	
	Get		BE EF	03	06 00	49 73	02 00	03 22	00 00	

Communication settings

Function	Operation		Header Data (7 bytes)				Command Data (6 bytes)			Description
			Header Code	Packet	Data Size	CRC	Action	Type	Setting Code	
White Balance - Red Gain	Set	0 - 200	BE EF	03	06 00	[*1]	01 00	B1 30	[*2]	[*1]: CRC (Low, High) [*2]: 00 00 (Min) - C8 00 (Max)
	Increment		BE EF	03	06 00	52 F4	04 00	B1 30	00 00	
	Decrement		BE EF	03	06 00	83 F5	05 00	B1 30	00 00	
	Get		BE EF	03	06 00	34 F4	02 00	B1 30	00 00	
White Balance - Green Gain	Set	0 - 200	BE EF	03	06 00	[*1]	01 00	B2 30	[*2]	[*1]: CRC (Low, High) [*2]: 00 00 (Min) - C8 00 (Max)
	Increment		BE EF	03	06 00	16 F4	04 00	B2 30	00 00	
	Decrement		BE EF	03	06 00	C7 F5	05 00	B2 30	00 00	
	Get		BE EF	03	06 00	70 F4	02 00	B2 30	00 00	
White Balance - Blue Gain	Set	0 - 200	BE EF	03	06 00	[*1]	01 00	B3 30	[*2]	[*1]: CRC (Low, High) [*2]: 00 00 (Min) - C8 00 (Max)
	Increment		BE EF	03	06 00	EA F5	04 00	B3 30	00 00	
	Decrement		BE EF	03	06 00	3B F4	05 00	B3 30	00 00	
	Get		BE EF	03	06 00	8C F5	02 00	B3 30	00 00	
White Balance - Red Offset	Set	0 - 200	BE EF	03	06 00	[*1]	01 00	B5 30	[*2]	[*1]: CRC (Low, High) [*2]: 00 00 (Min) - C8 00 (Max)
	Increment		BE EF	03	06 00	62 F5	04 00	B5 30	00 00	
	Decrement		BE EF	03	06 00	B3 F4	05 00	B5 30	00 00	
	Get		BE EF	03	06 00	04 F5	02 00	B5 30	00 00	
White Balance - Green Offset	Set	0 - 200	BE EF	03	06 00	[*1]	01 00	B6 30	[*2]	[*1]: CRC (Low, High) [*2]: 00 00 (Min) - C8 00 (Max)
	Increment		BE EF	03	06 00	26 F5	04 00	B6 30	00 00	
	Decrement		BE EF	03	06 00	F7 F4	05 00	B6 30	00 00	
	Get		BE EF	03	06 00	40 F5	02 00	B6 30	00 00	
White Balance - Blue Offset	Set	0 - 200	BE EF	03	06 00	[*1]	01 00	B7 30	[*2]	[*1]: CRC (Low, High) [*2]: 00 00 (Min) - C8 00 (Max)
	Increment		BE EF	03	06 00	DA F4	04 00	B7 30	00 00	
	Decrement		BE EF	03	06 00	0B F5	05 00	B7 30	00 00	
	Get		BE EF	03	06 00	BC F4	02 00	B7 30	00 00	
Color Manager - Red Hue	Set	0 - 100	BE EF	03	06 00	[*1]	01 00	00 27	[*2]	[*1]: CRC (Low, High) [*2]: 00 00 (Min) - 64 00 (Max)
	Increment		BE EF	03	06 00	6A 63	04 00	00 27	00 00	
	Decrement		BE EF	03	06 00	BB 62	05 00	00 27	00 00	
	Get		BE EF	03	06 00	0C 63	02 00	00 27	00 00	
Color Manager - Red Saturation	Set	0 - 100	BE EF	03	06 00	[*1]	01 00	10 27	[*2]	[*1]: CRC (Low, High) [*2]: 00 00 (Min) - 64 00 (Max)
	Increment		BE EF	03	06 00	AA 67	04 00	10 27	00 00	
	Decrement		BE EF	03	06 00	7B 66	05 00	10 27	00 00	
	Get		BE EF	03	06 00	CC 67	02 00	10 27	00 00	
Color Manager - Red Gain	Set	0 - 100	BE EF	03	06 00	[*1]	01 00	20 27	[*2]	[*1]: CRC (Low, High) [*2]: 00 00 (Min) - C8 00 (Max)
	Increment		BE EF	03	06 00	AA 68	04 00	20 27	00 00	
	Decrement		BE EF	03	06 00	7B 69	05 00	20 27	00 00	
	Get		BE EF	03	06 00	CC 68	02 00	20 27	00 00	
Color Manager - Green Hue	Set	0 - 100	BE EF	03	06 00	[*1]	01 00	02 27	[*2]	[*1]: CRC (Low, High) [*2]: 00 00 (Min) - 64 00 (Max)
	Increment		BE EF	03	06 00	D2 62	04 00	02 27	00 00	
	Decrement		BE EF	03	06 00	03 63	05 00	02 27	00 00	
	Get		BE EF	03	06 00	B4 62	02 00	02 27	00 00	
Color Manager - Green Saturation	Set	0 - 100	BE EF	03	06 00	[*1]	01 00	12 27	[*2]	[*1]: CRC (Low, High) [*2]: 00 00 (Min) - 64 00 (Max)
	Increment		BE EF	03	06 00	12 66	04 00	12 27	00 00	
	Decrement		BE EF	03	06 00	C3 67	05 00	12 27	00 00	
	Get		BE EF	03	06 00	74 66	02 00	12 27	00 00	

Communication settings

Function	Operation		Header Data (7 bytes)				Command Data (6 bytes)			Description
			Header Code	Packet	Data Size	CRC	Action	Type	Setting Code	
Color Manager - Green Gain	Set	0 - 100	BE EF	03	06 00	[*1]	01 00	22 27	[*2]	[*1]: CRC (Low, High) [*2]: 00 00 (Min) - 64 00 (Max)
	Increment		BE EF	03	06 00	12 69	04 00	22 27	00 00	
	Decrement		BE EF	03	06 00	C3 68	05 00	22 27	00 00	
	Get		BE EF	03	06 00	74 69	02 00	22 27	00 00	
Color Manager - Blue Hue	Set	0 - 100	BE EF	03	06 00	[*1]	01 00	04 27	[*2]	[*1]: CRC (Low, High) [*2]: 00 00 (Min) - 64 00 (Max)
	Increment		BE EF	03	06 00	5A 62	04 00	04 27	00 00	
	Decrement		BE EF	03	06 00	8B 63	05 00	04 27	00 00	
	Get		BE EF	03	06 00	3C 62	02 00	04 27	00 00	
Color Manager - Blue Saturation	Set	0 - 100	BE EF	03	06 00	[*1]	01 00	14 27	[*2]	[*1]: CRC (Low, High) [*2]: 00 00 (Min) - 64 00 (Max)
	Increment		BE EF	03	06 00	9A 66	04 00	14 27	00 00	
	Decrement		BE EF	03	06 00	4B 67	05 00	14 27	00 00	
	Get		BE EF	03	06 00	FC 66	02 00	14 27	00 00	
Color Manager - Blue Gain	Set	0 - 100	BE EF	03	06 00	[*1]	01 00	24 27	[*2]	[*1]: CRC (Low, High) [*2]: 00 00 (Min) - C8 00 (Max)
	Increment		BE EF	03	06 00	9A 69	04 00	24 27	00 00	
	Decrement		BE EF	03	06 00	4B 68	05 00	24 27	00 00	
	Get		BE EF	03	06 00	FC 69	02 00	24 27	00 00	
Color Manager - Cyan Hue	Set	0 - 100	BE EF	03	06 00	[*1]	01 00	03 27	[*2]	[*1]: CRC (Low, High) [*2]: 00 00 (Min) - C8 00 (Max)
	Increment		BE EF	03	06 00	2E 63	04 00	03 27	00 00	
	Decrement		BE EF	03	06 00	FF 62	05 00	03 27	00 00	
	Get		BE EF	03	06 00	48 63	02 00	03 27	00 00	
Color Manager - Cyan Saturation	Set	0 - 100	BE EF	03	06 00	[*1]	01 00	13 27	[*2]	[*1]: CRC (Low, High) [*2]: 00 00 (Min) - 64 00 (Max)
	Increment		BE EF	03	06 00	EE 67	04 00	13 27	00 00	
	Decrement		BE EF	03	06 00	3F 66	05 00	13 27	00 00	
	Get		BE EF	03	06 00	88 67	02 00	13 27	00 00	
Color Manager - Cyan Gain	Set	0 - 100	BE EF	03	06 00	[*1]	01 00	23 27	[*2]	[*1]: CRC (Low, High) [*2]: 00 00 (Min) - 64 00 (Max)
	Increment		BE EF	03	06 00	EE 68	04 00	23 27	00 00	
	Decrement		BE EF	03	06 00	3F 69	05 00	23 27	00 00	
	Get		BE EF	03	06 00	88 68	02 00	23 27	00 00	
Color Manager - Magenta Hue	Set	0 - 100	BE EF	03	06 00	[*1]	01 00	05 27	[*2]	[*1]: CRC (Low, High) [*2]: 00 00 (Min) - 64 00 (Max)
	Increment		BE EF	03	06 00	A6 63	04 00	05 27	00 00	
	Decrement		BE EF	03	06 00	77 62	05 00	05 27	00 00	
	Get		BE EF	03	06 00	C0 63	02 00	05 27	00 00	
Color Manager - Magenta Saturation	Set	0 - 100	BE EF	03	06 00	[*1]	01 00	15 27	[*2]	[*1]: CRC (Low, High) [*2]: 00 00 (Min) - 64 00 (Max)
	Increment		BE EF	03	06 00	66 67	04 00	15 27	00 00	
	Decrement		BE EF	03	06 00	B7 66	05 00	15 27	00 00	
	Get		BE EF	03	06 00	00 67	02 00	15 27	00 00	
Color Manager - Magenta Gain	Set	0 - 100	BE EF	03	06 00	[*1]	01 00	25 27	[*2]	[*1]: CRC (Low, High) [*2]: 00 00 (Min) - 64 00 (Max)
	Increment		BE EF	03	06 00	66 68	04 00	25 27	00 00	
	Decrement		BE EF	03	06 00	B7 69	05 00	25 27	00 00	
	Get		BE EF	03	06 00	00 68	02 00	25 27	00 00	
Color Manager - Yellow Hue	Set	0 - 100	BE EF	03	06 00	[*1]	01 00	01 27	[*2]	[*1]: CRC (Low, High) [*2]: 00 00 (Min) - 64 00 (Max)
	Increment		BE EF	03	06 00	96 62	04 00	01 27	00 00	
	Decrement		BE EF	03	06 00	47 63	05 00	01 27	00 00	
	Get		BE EF	03	06 00	F0 62	02 00	01 27	00 00	

Communication settings

Function	Operation		Header Data (7 bytes)				Command Data (6 bytes)			Description
			Header Code	Packet	Data Size	CRC	Action	Type	Setting Code	
Color Manager - Yellow Saturation	Set	0 - 100	BE EF	03	06 00	[*1]	01 00	11 27	[*2]	[*1]: CRC (Low, High) [*2]: 00 00 (Min) - 64 00 (Max)
	Increment		BE EF	03	06 00	56 66	04 00	11 27	00 00	
	Decrement		BE EF	03	06 00	87 67	05 00	11 27	00 00	
	Get		BE EF	03	06 00	30 66	02 00	11 27	00 00	
Color Manager - Yellow Gain	Set	0 - 100	BE EF	03	06 00	[*1]	01 00	21 27	[*2]	[*1]: CRC (Low, High) [*2]: 00 00 (Min) - 64 00 (Max)
	Increment		BE EF	03	06 00	56 69	04 00	21 27	00 00	
	Decrement		BE EF	03	06 00	87 68	05 00	21 27	00 00	
	Get		BE EF	03	06 00	30 69	02 00	21 27	00 00	
Color Manager - White Gain R	Set	0 - 100	BE EF	03	06 00	[*1]	01 00	28 27	[*2]	[*1]: CRC (Low, High) [*2]: 00 00 (Min) - 64 00 (Max)
	Increment		BE EF	03	06 00	CA 6A	04 00	28 27	00 00	
	Decrement		BE EF	03	06 00	1B 6B	05 00	28 27	00 00	
	Get		BE EF	03	06 00	AC 6A	02 00	28 27	00 00	
Color Manager - White Gain G	Set	0 - 100	BE EF	03	06 00	[*1]	01 00	2A 27	[*2]	[*1]: CRC (Low, High) [*2]: 00 00 (Min) - 64 00 (Max)
	Increment		BE EF	03	06 00	72 6B	04 00	2A 27	00 00	
	Decrement		BE EF	03	06 00	A3 6A	05 00	2A 27	00 00	
	Get		BE EF	03	06 00	14 6B	02 00	2A 27	00 00	
Color Manager - White Gain B	Set	0 - 100	BE EF	03	06 00	[*1]	01 00	2C 27	[*2]	[*1]: CRC (Low, High) [*2]: 00 00 (Min) - 64 00 (Max)
	Increment		BE EF	03	06 00	FA 6B	04 00	2C 27	00 00	
	Decrement		BE EF	03	06 00	2B 6A	05 00	2C 27	00 00	
	Get		BE EF	03	06 00	9C 6B	02 00	2C 27	00 00	
Input Source	Set	HDMI 1	BE EF	03	06 00	0E D2	01 00	00 20	03 00	
		HDMI 2	BE EF	03	06 00	6E D6	01 00	00 20	0D 00	
		HDMI 3 / MHL	BE EF	03	06 00	9E D6	01 00	00 20	0E 00	
		Computer in 1	BE EF	03	06 00	FE D2	01 00	00 20	00 00	
		Video	BE EF	03	06 00	6E D3	01 00	00 20	01 00	
		HDBaseT	BE EF	03	06 00	AE DE	01 00	00 20	11 00	
	Get	BE EF	03	06 00	CD D2	02 00	00 20	00 00		
Installation	Set	Front Tabletop	BE EF	03	06 00	C7 D2	01 00	01 30	00 00	
		Rear Tabletop	BE EF	03	06 00	57 D3	01 00	01 30	01 00	
		Front Ceiling	BE EF	03	06 00	37 D2	01 00	01 30	03 00	
		Rear Ceiling	BE EF	03	06 00	A7 D3	01 00	01 30	02 00	
	Get	BE EF	03	06 00	F4 D2	02 00	01 30	00 00		
Aspect	Set	16:10	BE EF	03	06 00	3E D6	01 00	08 20	0A 00	
		4:3	BE EF	03	06 00	9E D0	01 00	08 20	00 00	
		16:9	BE EF	03	06 00	0E D1	01 00	08 20	01 00	
		Letter Box	BE EF	03	6 00	3E D3	01 00	08 20	06 00	
		Native	BE EF	03	6 00	5E D7	01 00	08 20	08 00	
		2.35:1	BE EF	03	6 00	0E D4	01 00	08 20	0D 00	
	Get	BE EF	03	06 00	AD D0	02 00	08 20	00 00		
H Keystone	Set	0 - 100	BE EF	03	06 00	[*1]	01 00	0B 20	[*2]	[*1]: CRC (Low, High) [*2]: 00 00 (Min) - 64 00 (Max)
	Increment		BE EF	03	06 00	8F D0	04 00	0B 20	00 00	
	Decrement		BE EF	03	06 00	5E D1	05 00	0B 20	00 00	
	Get		BE EF	03	06 00	E9 D0	02 00	0B 20	00 00	

Communication settings

Function	Operation		Header Data (7 bytes)				Command Data (6 bytes)			Description	
			Header Code	Packet	Data Size	CRC	Action	Type	Setting Code		
V Keystone	Set	0 - 120	BE EF	03	06 00	[*1]	01 00	07 20	[*2]	[*1]: CRC (Low, High) [*2]: 00 00 (Min) - 78 00 (Max)	
		Increment	BE EF	03	06 00	DF D3	04 00	07 20	00 00		
		Decrement	BE EF	03	06 00	0E D2	05 00	07 20	00 00		
		Get	BE EF	03	06 00	B9 D3	02 00	07 20	00 00		
Digital Zoom	Set	90 - 110	BE EF	03	06 00	[*1]	01 00	94 22	[*2]	[*1]: CRC (Low, High) [*2]: 5A 00 (Min) - 6E 00 (Max)	
		Increment	BE EF	03	06 00	5B 5F	04 00	94 22	00 00		
		Decrement	BE EF	03	06 00	8A 5E	05 00	94 22	00 00		
		Get	BE EF	03	06 00	3D 5F	02 00	94 22	00 00		
Volume	Set	0 - 20	BE EF	03	06 00	[*1]	02 00	01 20	[*2]	[*1]: CRC (Low, High) [*2]: 00 00 (Min) - 14 00 (Max)	
		Increment	BE EF	03	06 00	57 D3	04 00	01 20	00 00		
		Decrement	BE EF	03	06 00	86 D2	05 00	01 20	00 00		
		Get	BE EF	03	06 00	31 D3	02 00	01 20	00 00		
Mute	Set	OFF	BE EF	03	06 00	46 D3	01 00	02 20	00 00		
		ON	BE EF	03	06 00	D6 D2	01 00	02 20	01 00		
	Get		BE EF	03	06 00	75 D3	02 00	02 20	00 00		
Language	Set	English	BE EF	03	06 00	F7 D3	01 00	05 30	00 00		
		French	BE EF	03	06 00	67 D2	01 00	05 30	01 00		
		German	BE EF	03	06 00	97 D2	01 00	05 30	02 00		
		Spanish	BE EF	03	06 00	07 D3	01 00	05 30	03 00		
		Portuese	BE EF	03	06 00	C7 D1	01 00	05 30	07 00		
		Simplified Chinese	BE EF	03	06 00	A7 D5	01 00	05 30	09 00		
		Traditional Chinese	BE EF	03	06 00	37 DE	01 00	05 30	10 00		
		Italian	BE EF	03	06 00	37 D1	01 00	05 30	04 00		
		Norwegian	BE EF	03	06 00	A7 D0	01 00	05 30	05 00		
		Swedish	BE EF	03	06 00	C7 D4	01 00	05 30	0B 00		
		Dutch	BE EF	03	06 00	57 D0	01 00	05 30	06 00		
		Russian	BE EF	03	06 00	F7 D6	01 00	05 30	0C 00		
		Polish	BE EF	03	06 00	97 D7	01 00	05 30	0E 00		
		Finnish	BE EF	03	06 00	67 D7	01 00	05 30	0D 00		
		Greek	BE EF	03	06 00	07 DC	01 00	05 30	17 00		
		Korean	BE EF	03	06 00	57 D5	01 00	05 30	0A 00		
		Hungarian	BE EF	03	06 00	C7 DE	01 00	05 30	13 00		
		Czech	BE EF	03	06 00	57 DF	01 00	05 30	12 00		
		Arabic	BE EF	03	06 00	37 DB	01 00	05 30	1C 00		
		Turkish	BE EF	03	06 00	07 D6	01 00	05 30	0F 00		
		Vietnamese	BE EF	03	06 00	37 CA	01 00	05 30	20 00		
		Japanese	BE EF	03	06 00	37 D4	01 00	05 30	08 00		
		Thai	BE EF	03	06 00	07 D9	01 00	05 30	1B 00		
		Farsi	BE EF	03	06 00	A7 DA	01 00	05 30	1D 00		
		Hebrew	BE EF	03	06 00	A7 CB	01 00	05 30	21 00		
		Danish	BE EF	03	06 00	A7 DF	01 00	05 30	11 00		
		French Canadian	BE EF	03	06 00	57 CB	01 00	05 30	22 00		
		Get		BE EF	03	06 00	C4 D3	02 00	05 30		00 00

Communication settings

Function	Operation		Header Data (7 bytes)				Command Data (6 bytes)			Description
			Header Code	Packet	Data Size	CRC	Action	Type	Setting Code	
Security Lock	Set	Off	BE EF	03	06 00	FA 37	01 00	10 36	00 00	
		On	BE EF	03	06 00	6A 36	01 00	10 36	01 00	
Security Lock Status	Get		BE EF	03	06 00	C9 37	02 00	10 36	00 00	0: Off, 1:On
No Signal	Set	Logo	BE EF	03	06 00	CB E3	01 00	04 30	40 00	
		Black	BE EF	03	06 00	AB D1	01 00	04 30	06 00	
		Blue	BE EF	03	06 00	FB D2	01 00	04 30	03 00	
	Get		BE EF	03	06 00	38 D2	02 00	04 30	00 00	
C.C. Display	Set	Off	BE EF	03	06 00	FA 62	01 00	00 37	00 00	
		On	BE EF	03	06 00	6A 63	01 00	00 37	01 00	
	Get		BE EF	03	06 00	C9 62	02 00	00 37	00 00	
Key Lock - CONTROL PANEL	Set	Off	BE EF	03	06 00	03 96	01 00	11 24	00 00	keypad only, not include remote controller
		On	BE EF	03	06 00	93 97	01 00	11 24	01 00	
	Get		BE EF	03	06 00	30 96	02 00	11 24	00 00	
3D - DLP Link	Set	Off	BE EF	03	06 00	52 58	01 00	8D 22	00 00	
		On	BE EF	03	06 00	C2 59	01 00	8D 22	01 00	
		IR	BE EF	03	06 00	32 59	01 00	8D 22	02 00	
	Get		BE EF	03	06 00	61 58	02 00	8D 22	00 00	
3D Sync Invert	Set	Off	BE EF	03	06 00	CE 5B	01 00	84 22	00 00	
		On	BE EF	03	06 00	5E 5A	01 00	84 22	01 00	
	Get		BE EF	03	06 00	FD 5B	02 00	84 22	00 00	
3D Format	Set	Frame Sequential	BE EF	03	06 00	1A 5A	01 00	8B 22	04 00	
		Top and Bottom	BE EF	03	06 00	2A 58	01 00	8B 22	03 00	
		Side by Side	BE EF	03	06 00	BA 59	01 00	8B 22	02 00	
		Frame Packing	BE EF	03	06 00	8A 5B	01 00	8B 22	05 00	
	Get		BE EF	03	06 00	E9 58	02 00	8B 22	00 00	
Pattern	Set	Off	BE EF	03	06 00	FB FA	01 00	80 30	00 00	
		RGB Ramp	BE EF	03	06 00	5B E2	01 00	80 30	22 00	
		Color Bar	BE EF	03	06 00	AB F6	01 00	80 30	11 00	
		Step Bar	BE EF	03	06 00	CB F2	01 00	80 30	1F 00	
		Checkerboard	BE EF	03	06 00	AB F3	01 00	80 30	1D 00	
		Hatch	BE EF	03	06 00	5B F6	01 00	80 30	12 00	
		Horizontal Lines	BE EF	03	06 00	CB E3	01 00	80 30	23 00	
		Vertical Lines	BE EF	03	06 00	FB E1	01 00	80 30	24 00	
		Diagonal lines	BE EF	03	06 00	3B E3	01 00	80 30	20 00	
		Horizontal Ramp	BE EF	03	06 00	0B FA	01 00	80 30	03 00	
		Vertical Ramp	BE EF	03	06 00	AB E2	01 00	80 30	21 00	
		White	BE EF	03	06 00	0B F5	01 00	80 30	17 00	
		Red	BE EF	03	06 00	FB F5	01 00	80 30	14 00	
		Green	BE EF	03	06 00	6B F4	01 00	80 30	15 00	
		Blue	BE EF	03	06 00	9B F4	01 00	80 30	16 00	
		Black	BE EF	03	06 00	FB F0	01 00	80 30	18 00	
	Get		BE EF	03	06 00	C8 FA	02 00	80 30	00 00	

Communication settings

Function	Operation		Header Data (7 bytes)				Command Data (6 bytes)			Description
			Header Code	Packet	Data Size	CRC	Action	Type	Setting Code	
Horz Shift	Set	0 - 100	BE EF	03	06 00	[*1]	01 00	10 30	[*2]	"[*1]: CRC (Low, High) [*2]: 00 00 (Min) - 64 00 (Max) "
	Increment		BE EF	03	06 00	AE D7	04 00	10 30	00 00	
	Decrement		BE EF	03	06 00	7F D6	05 00	10 30	00 00	
	Get		BE EF	03	06 00	C8 D7	02 00	10 30	00 00	
Vert Shift	Set	0 - 100	BE EF	03	06 00	[*1]	01 00	11 30	[*2]	"[*1]: CRC (Low, High) [*2]: 00 00 (Min) - 64 00 (Max) "
	Increment		BE EF	03	06 00	52 D6	04 00	11 30	00 00	
	Decrement		BE EF	03	06 00	83 D7	05 00	11 30	00 00	
	Get		BE EF	03	06 00	34 D6	02 00	11 30	00 00	
"Warping - Top Left Corner - x"	Set	0 - 60	BE EF	03	06 00	[*1]	01 00	21 21	[*2]	"[*1]: CRC (Low, High) [*2]: 00 00 (Min) - 3C 00 (Max) "
	Increment		BE EF	03	06 00	57 89	04 00	21 21	00 00	
	Decrement		BE EF	03	06 00	86 88	05 00	21 21	00 00	
	Get		BE EF	03	06 00	31 89	02 00	21 21	00 00	
"Warping - Top Left Corner - y"	Set	0 - 60	BE EF	03	06 00	[*1]	01 00	22 21	[*2]	"[*1]: CRC (Low, High) [*2]: 00 00 (Min) - 3C 00 (Max) "
	Increment		BE EF	03	06 00	13 89	04 00	22 21	00 00	
	Decrement		BE EF	03	06 00	C2 88	05 00	22 21	00 00	
	Get		BE EF	03	06 00	75 89	02 00	22 21	00 00	
"Warping - Top Right Corner - x"	Set	0 - 60	BE EF	03	06 00	[*1]	01 00	23 21	[*2]	"[*1]: CRC (Low, High) [*2]: 00 00 (Min) - 3C 00 (Max) "
	Increment		BE EF	03	06 00	EF 88	04 00	23 21	00 00	
	Decrement		BE EF	03	06 00	3E 89	05 00	23 21	00 00	
	Get		BE EF	03	06 00	89 88	02 00	23 21	00 00	
"Warping - Top Right Corner - y"	Set	0 - 60	BE EF	03	06 00	[*1]	01 00	24 21	[*2]	"[*1]: CRC (Low, High) [*2]: 00 00 (Min) - 3C 00 (Max) "
	Increment		BE EF	03	06 00	9B 89	04 00	24 21	00 00	
	Decrement		BE EF	03	06 00	4A 88	05 00	24 21	00 00	
	Get		BE EF	03	06 00	FD 89	02 00	24 21	00 00	
"Warping - Bottom Left Corner - x"	Set	0 - 60	BE EF	03	06 00	[*1]	01 00	25 21	[*2]	"[*1]: CRC (Low, High) [*2]: 00 00 (Min) - 3C 00 (Max) "
	Increment		BE EF	03	06 00	67 88	04 00	25 21	00 00	
	Decrement		BE EF	03	06 00	B6 89	05 00	25 21	00 00	
	Get		BE EF	03	06 00	01 88	02 00	25 21	00 00	
"Warping - Bottom Left Corner - y"	Set	0 - 60	BE EF	03	06 00	[*1]	01 00	26 21	[*2]	"[*1]: CRC (Low, High) [*2]: 00 00 (Min) - 3C 00 (Max) "
	Increment		BE EF	03	06 00	23 88	04 00	26 21	00 00	
	Decrement		BE EF	03	06 00	F2 89	05 00	26 21	00 00	
	Get		BE EF	03	06 00	45 88	02 00	26 21	00 00	
"Warping - Bottom Right Corner - x"	Set	0 - 60	BE EF	03	06 00	[*1]	01 00	27 21	[*2]	"[*1]: CRC (Low, High) [*2]: 00 00 (Min) - 3C 00 (Max) "
	Increment		BE EF	03	06 00	DF 89	04 00	27 21	00 00	
	Decrement		BE EF	03	06 00	0E 88	05 00	27 21	00 00	
	Get		BE EF	03	06 00	B9 89	02 00	27 21	00 00	
"Warping - Bottom Right Corner - y"	Set	0 - 60	BE EF	03	06 00	[*1]	01 00	28 21	[*2]	"[*1]: CRC (Low, High) [*2]: 00 00 (Min) - 3C 00 (Max) "
	Increment		BE EF	03	06 00	CB 8A	04 00	28 21	00 00	
	Decrement		BE EF	03	06 00	1A 8B	05 00	28 21	00 00	
	Get		BE EF	03	06 00	AD 8A	02 00	28 21	00 00	
Warping - Reset	Execute		BE EF	03	06 00	F1 99	06 00	72 21	00 00	
Auto Search	Set	Off	BE EF	03	06 00	B6 D6	01 00	16 20	00 00	
		On	BE EF	03	06 00	26 D7	01 00	16 20	01 00	
	Get		BE EF	03	06 00	85 D6	02 00	16 20	00 00	

Communication settings

Function	Operation		Header Data (7 bytes)				Command Data (6 bytes)			Description
			Header Code	Packet	Data Size	CRC	Action	Type	Setting Code	
Auto Power Off	Set	0-180	BE EF	03	06 00	[*1]	01 00	10 31	[*2]	[*1]: CRC (Low, High) [*2]: 00 00 (Min) - B4 00 (Max) 1 step = 5 min
		Increment	BE EF	03	06 00	6E 86	04 00	10 31	00 00	
		Decrement	BE EF	03	06 00	BF 87	05 00	10 31	00 00	
		Get	BE EF	03	06 00	08 86	02 00	10 31	00 00	
Direct Power On	Set	Off	BE EF	03	06 00	3B 89	01 00	20 31	00 00	
		On	BE EF	03	06 00	AB 88	01 00	20 31	01 00	
		Get	BE EF	03	06 00	08 89	02 00	20 31	00 00	
Power Mode	Set	Normal	BE EF	03	06 00	3B 23	01 00	00 33	00 00	
		Eco-1	BE EF	03	06 00	AB 22	01 00	00 33	01 00	
		Eco-2	BE EF	03	06 00	5B 22	01 00	00 33	02 00	
		Dimming	BE EF	03	06 00	CB 23	01 00	00 33	03 00	
		Extreme Dimming	BE EF	03	06 00	FB 21	01 00	00 33	04 00	
		Custom	BE EF	03	06 00	3B 37	01 00	00 33	30 00	
		Get	BE EF	03	06 00	08 23	02 00	00 33	00 00	
Factory Reset		Execute	BE EF	03	06 00	98 8D	06 00	30 71	00 00	
Input		Get	BE EF	03	06 00	CD D2	02 00	00 20	00 00	
V Active		Get	BE EF	03	06 00	7A 86	02 00	12 11	00 00	Vertical resolution
H Active		Get	BE EF	03	06 00	7A 89	02 00	22 11	00 00	Horizontal resolution
Vert. Frequency		Get	BE EF	03	06 00	8A 83	02 00	06 11	00 00	Vertical frequency, fV[Hz]*100
Light Hours - High		Get	BE EF	03	06 00	2A FD	02 00	9E 10	00 00	
Light Hours - Low		Get	BE EF	03	06 00	C2 FF	02 00	90 10	00 00	
Software Version Index	Set	0-63	BE EF	03	06 00	[*1]	01 00	1C 10	[*2]	[*1]: CRC (Low, High) [*2]: 00 00 (Min) - 3F 00 (Max)
		Get	BE EF	03	06 00	52 D5	02 00	1C 10	00 00	
Software Version 1		Get	BE EF	03	06 00	AE D4	02 00	1D 10	00 00	
Remote ID		Get	BE EF	03	06 00	AC 30	02 00	08 26	00 00	
Serial Number Index	Set	0 - 25	BE EF	03	06 00	[*1]	01 00	18 10	[*2]	[*1]: CRC (Low, High) [*2]: 00 00 (Min) - 19 00 (Max)
		Get	BE EF	03	06 00	C0 57	02 00	18 10	00 00	
Serial Number Character		Get	BE EF	03	06 00	9E D5	02 00	19 10	00 00	
Memu Position	Set	center	BE EF	03	06 00	97 D7	01 00	1D 30	04 00	
		Down	BE EF	03	06 00	97 D8	01 00	1D 30	10 00	
		Up	BE EF	03	06 00	07 D9	01 00	1D 30	11 00	
		Left	BE EF	03	06 00	F7 D9	01 00	1D 30	12 00	
		Right	BE EF	03	06 00	67 D8	01 00	1D 30	13 00	
		Get	BE EF	03	06 00	64 D5	02 00	1D 30	00 00	
Translucent Menu	Set	0%	BE EF	03	06 00	E6 5A	01 00	9A 22	00 00	
		25%	BE EF	03	06 00	76 56	01 00	9A 22	19 00	
		50%	BE EF	03	06 00	86 48	01 00	9A 22	32 00	
		75%	BE EF	03	06 00	16 6B	01 00	9A 22	4B 00	
		100%	BE EF	03	06 00	26 77	01 00	9A 22	64 00	
		Get	BE EF	03	06 00	D5 5D	02 00	9A 22	00 00	

Communication settings

Function	Operation		Header Data (7 bytes)				Command Data (6 bytes)			Description
			Header Code	Packet	Data Size	CRC	Action	Type	Setting Code	
Standby Power	Set	Saving	BE EF	03	06 00	46 D3	01 00	01 60	01 00	(RJ45 Power Off)
		Normal	BE EF	03	06 00	D6 D2	01 00	01 60	00 00	
	Get		BE EF	03	06 00	E5 D2	02 00	01 60	00 00	
High Altitude	Set	Normal	BE EF	03	06 00	E3 12	01 00	00 4C	00 00	
		High	BE EF	03	06 00	73 13	01 00	00 4C	01 00	
	Get		BE EF	03	06 00	D0 12	02 00	00 4C	00 00	
Light Hours Normal - High	Get		BE EF	03	06 00	31 54	02 00	B1 22	00 00	
Light Hours Normal - Low	Get		BE EF	03	06 00	CD 55	02 00	B0 22	00 00	
Light Hours Eco - High	Get		BE EF	03	06 00	89 55	02 00	B3 22	00 00	
Light Hours Eco - Low	Get		BE EF	03	06 00	75 54	02 00	B2 22	00 00	
Light Hours Eco Plus - High	Get		BE EF	03	06 00	01 55	02 00	B5 22	00 00	
Light Hours Eco Plus - Low	Get		BE EF	03	06 00	FD 54	02 00	B4 22	00 00	
Light Hours Dimming - High	Get		BE EF	03	06 00	B9 54	02 00	B7 22	00 00	
Light Hours Dimming - Low	Get		BE EF	03	06 00	45 55	02 00	B6 22	00 00	
Light Hours Extream Dimming - High	Get		BE EF	03	06 00	51 56	02 00	B9 22	00 00	
Light Hours Extream Dimming - Low	Get		BE EF	03	06 00	AD 57	02 00	B8 22	00 00	
Light Hours Custom - High	Get		BE EF	03	06 00	E9 57	02 00	BB 22	00 00	system create new item
Light Hours Custom - Low	Get		BE EF	03	06 00	15 56	02 00	BA 22	00 00	system create new item
Remote ID	Set	All	BE EF	03	06 00	9F 30	01 00	08 26	00 00	
		1	BE EF	03	06 00	0F 31	01 00	08 26	01 00	
		2	BE EF	03	06 00	FF 31	01 00	08 26	02 00	
		3	BE EF	03	06 00	6F 30	01 00	08 26	03 00	
		4	BE EF	03	06 00	5F 32	01 00	08 26	04 00	
		5	BE EF	03	06 00	CF 33	01 00	08 26	05 00	
		6	BE EF	03	06 00	3F 33	01 00	08 26	06 00	
	7	BE EF	03	06 00	AF 32	01 00	08 26	07 00		
Get		BE EF	03	06 00	AC 30	02 00	08 26	00 00		

Communication settings

Function	Operation	Header Data (7 bytes)				Command Data (6 bytes)			Description
		Header Code	Packet	Data Size	CRC	Action	Type	Setting Code	
Network Status	Get	BE EF	03	06 00	B5 5F	02 00	92 22	00 00	Diconnect; 0 Connect; 1
DHCP	Get	BE EF	03	06 00	0F 06	02 00	10 29	00 00	Off; 0 On; 1
IP Address 1st	Get	BE EF	03	06 00	F3 07	02 00	11 29	00 00	
IP Address 2st	Get	BE EF	03	06 00	B7 07	02 00	12 29	00 00	
IP Address 3rd	Get	BE EF	03	06 00	4B 06	02 00	13 29	00 00	
IP Address 4th	Get	BE EF	03	06 00	3F 07	02 00	14 29	00 00	
Subnet Mask 1st	Get	BE EF	03	06 00	C3 06	02 00	15 29	00 00	
Subnet Mask 2st	Get	BE EF	03	06 00	87 06	02 00	16 29	00 00	
Subnet Mask 3rd	Get	BE EF	03	06 00	7B 07	02 00	17 29	00 00	
Subnet Mask 4th	Get	BE EF	03	06 00	6F 04	02 00	18 29	00 00	
Gateway 1st	Get	BE EF	03	06 00	93 05	02 00	19 29	00 00	
Gateway 2st	Get	BE EF	03	06 00	D7 05	02 00	1A 29	00 00	
Gateway 3rd	Get	BE EF	03	06 00	2B 04	02 00	1B 29	00 00	
Gateway 4th	Get	BE EF	03	06 00	5F 05	02 00	1C 29	00 00	
DNS 1st	Get	BE EF	03	06 00	F3 08	02 00	21 29	00 00	
DNS 2st	Get	BE EF	03	06 00	B7 08	02 00	22 29	00 00	
DNS 3rd	Get	BE EF	03	06 00	4B 09	02 00	23 29	00 00	
DNS 4th	Get	BE EF	03	06 00	3F 08	02 00	24 29	00 00	

HDBaseT - TX Box (RS232C, IR)	Set	Off	BE EF	03	06 00	2A 5D	01 00	9F 22	00 00	
		On	BE EF	03	06 00	BA 5C	01 00	9F 22	01 00	
	Get	BE EF	03	06 00	19 5D	02 00	9F 22	00 00		
Front IR	Set	Off	BE EF	03	06 00	FF 32	01 00	00 26	00 00	
		On	BE EF	03	06 00	6F 33	01 00	00 26	01 00	
	Get	BE EF	03	06 00	CC 32	02 00	00 26	00 00		
Rear IR	Set	Off	BE EF	03	06 00	03 33	01 00	01 26	00 00	
		On	BE EF	03	06 00	93 32	01 00	01 26	01 00	
	Get	BE EF	03	06 00	30 33	02 00	01 26	00 00		
Sleep Timer	Set	0-600	BE EF	03	06 00	[*1]	01 00	9E 22	[*2]	[*1]: CRC (Low, High) [*2]: 00 00 (Min) - 58 02 (Max) 1 step = 5 min
		Increment	BE EF	03	06 00	83 5C	04 00	9E 22	00 00	
	Decrement	BE EF	03	06 00	52 5D	05 00	9E 22	00 00		
	Get	BE EF	03	06 00	E5 5C	02 00	9E 22	00 00		
SOURCE SKIP HDMI 1	Set	SKIP	BE EF	03	06 00	2A 79	01 00	23 22	01 00	
		NORMAL	BE EF	03	06 00	BA 78	01 00	23 22	00 00	
	Get	BE EF	03	06 00	89 78	02 00	23 22	00 00		
SOURCE SKIP HDMI 2	Set	SKIP	BE EF	03	06 00	C2 7B	01 00	2D 22	01 00	
		NORMAL	BE EF	03	06 00	52 7A	01 00	2D 22	00 00	
	Get	BE EF	03	06 00	61 7A	02 00	2D 22	00 00		

Communication settings

Function	Operation		Header Data (7 bytes)				Command Data (6 bytes)			Description
			Header Code	Packet	Data Size	CRC	Action	Type	Setting Code	
SOURCE SKIP HDMI 3 / MHL	Set	SKIP	BE EF	03	06 00	86 7B	01 00	2E 22	01 00	
		NORMAL	BE EF	03	06 00	16 7A	01 00	2E 22	00 00	
	Get		BE EF	03	06 00	25 7A	02 00	2E 22	00 00	
SOURCE SKIP COMPUTER IN	Set	SKIP	BE EF	03	06 00	6E 79	01 00	20 22	01 00	
		NORMAL	BE EF	03	06 00	FE 78	01 00	20 22	00 00	
	Get		BE EF	03	06 00	CD 78	02 00	20 22	00 00	
SOURCE SKIP VIDEO	Set	SKIP	BE EF	03	06 00	92 78	01 00	21 22	01 00	
		NORMAL	BE EF	03	06 00	02 79	01 00	21 22	00 00	
	Get		BE EF	03	06 00	31 79	02 00	21 22	00 00	
SOURCE SKIP HDBaseT	Set	SKIP	BE EF	03	06 00	26 EB	01 00	D6 20	01 00	
		NORMAL	BE EF	03	06 00	B6 EA	01 00	D6 20	00 00	
	Get		BE EF	03	06 00	85 EA	02 00	D6 20	00 00	
Power Level	Set	25 - 100	BE EF	03	06 00	[*1]	01 00	07 33	[*2]	"[*1]: CRC (Low, High) [*2]: 19 00 (Min) - 64 00 (Max) "
		Increment	BE EF	03	06 00	1A 22	04 00	07 33	00 00	
		Decrement	BE EF	03	06 00	CB 23	05 00	07 33	00 00	
	Get		BE EF	03	06 00	7C 22	02 00	07 33	00 00	

Power	Set	Off	BE EF	03	06 00	2A D3	01 00	00 60	00 00	0: Off (Standby) 1: On (Imaging) 2: Cooling 4: Warning
		On	BE EF	03	06 00	BA D2	01 00	00 60	01 00	
	Get		BE EF	03	06 00	19 D3	02 00	00 60	00 00	
Error Status	Get		BE EF	03	06 00	D9 D8	02 00	20 60	00 00	0: Normal 1: Cover error 2: Fan error 3: Lazer error 4: Temp Error 7: Other Error 8: Filter Warning 128: Other Error
Freeze	Set	Off	BE EF	03	06 00	83 D2	01 00	02 30	00 00	
		On	BE EF	03	06 00	13 D3	01 00	02 30	01 00	
	Get		BE EF	03	06 00	B0 D2	02 00	02 30	00 00	
AV Mute	Set	Off	BE EF	03	06 00	FE F0	01 00	A0 20	00 00	same function as Blank
		On	BE EF	03	06 00	6E F1	01 00	A0 20	01 00	
	Get		BE EF	03	06 00	CD F0	02 00	A0 20	00 00	
Blank	Set	Off	BE EF	03	06 00	FB D8	01 00	20 30	00 00	same function as AV Mute
		On	BE EF	03	06 00	6B D9	01 00	20 30	01 00	
	Get		BE EF	03	06 00	C8 D8	02 00	20 30	00 00	
MHL Mode	Set	Projector Mode	BE EF	03	06 00	C2 50	01 00	A1 22	00 00	
		MHL Mode	BE EF	03	06 00	52 51	01 00	A1 22	01 00	
	Get		BE EF	03	06 00	F1 50	02 00	A1 22	00 00	
Detail Error Code	Get		BE EF	03	06 00	0D 5E	02 00	90 22	00 00	Detail Error Code

Communication settings

PJLink command

POWR	Power Control	0 = Standby 1 = Power On
POWR ?	Power Status inquiry	0 = Standby 1 = Power On 2 = Cool Down
INPT	Input Source selection	11 = COMPUTER IN 23 = Video 31 = HDMI 1 32 = HDMI 2 33 = HDMI 3 / MHL 36 = HDBaseT
INPT ?	Input Source inquiry	11 = COMPUTER IN 23 = Video 31 = HDMI 1 32 = HDMI 2 33 = HDMI 3 / MHL 36 = HDBaseT
AVMT	AV Mute	30 = AV Mute off 31 = AV Mute on
AVMT ?	AV Mute inquiry	30 = AV Mute off 31 = AV Mute on
ERST ?	Error Status inquiry	1st byte: Refers to Fan error; one of 0 to 2 2nd byte: Refers to Laser error; one of 0 to 2 3rd byte: Refers to Temperature error; one of 0 to 2 4th byte: Refers to Cover error; one of 0 to 2 6th byte: Refers to Other error; one of 0 to 2 The meaning of 0 to 2 is as given below 0 = Error is not detected 1 = Warning 2 = Error
LAMP ?	Laser Status inquiry	1st number (digits 1 to 5): Laser Hours 2nd number: 0 = Lamp off, 1 = Lamp on
INST ?	Input Source List inquiry	11 12 23 31 32 33 36
NAME ?	Projector Name inquiry	Responds with the name set in the item PROJECTOR NAME of the Crestron
INF1 ?	Brand Name inquiry	HITACHI/(Dukane)
INF2 ?	Model Name inquiry	LP-WU6500(8965WUSS)
CLASS ?	Class Information inquiry	1

Note: For specifications of PJLink™, see the web site of the Japan Business Machine and Information System Industries Association.

URL: <http://pjlink.jbmia.or.jp/>

Note: The Dukane model described in this document is manufactured by Hitachi and uses the same firmware, software programs, control code, and accessory parts. The equivalent Dukane to Hitachi models is 8965WUSS (LP-WU6500).

Projection distance vs projection size table

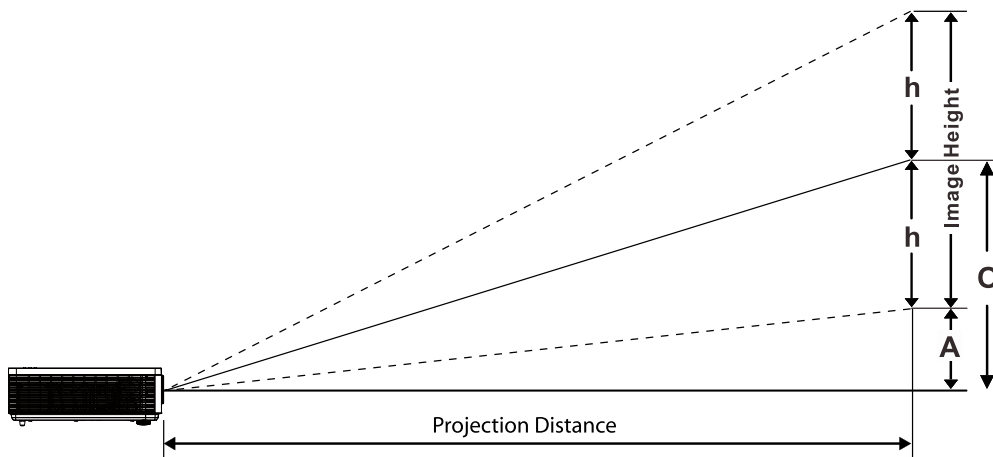

TR: 1.15~1.9, offset=65%

	Wide				Tele			
Distance (m)	1.61	2.48	3.72	4.95	1.64	2.46	3.27	4.91
Diagonal (")	65	100	150	200	40	60	80	120
Image Width (mm)	1400	2154	3231	4308	862	1292	1723	2585
Image Height (mm)	875	1346	2019	2692	538	808	1077	1615
h (mm)	438	673	1010	1346	269	404	538	808
O (mm)	569	875	1313	1750	350	525	700	1050
A (mm)	131	202	303	404	81	121	162	242

Copyright information

Copyright

Copyright 2017. All rights reserved. No part of this publication may be reproduced, transmitted, transcribed, stored in a retrieval system or translated into any language or computer language, in any form or by any means, electronic, mechanical, magnetic, optical, chemical, manual or otherwise, without the prior written permission of this company.

The reproduction, transfer or copy of all or any part of this document is not permitted without express written consent.

Disclaimer

This company makes no representations or warranties, either expressed or implied, with respect to the contents hereof and specifically disclaims any warranties, merchantability or fitness for any particular purpose. Further, this company reserves the right to revise this publication and to make changes from time to time in the contents hereof without obligation to notify any person of such revision or changes.

The illustrations in this manual are for illustrative purposes. They may differ slightly from your projector.

Trademark

- DLP and Digital Micromirror Device (DMD) are trademarks of Texas Instruments. Others are copyrights of their respective companies or organizations.
- Registered trademarks of HDMI Licensing LLC in the United States and other countries.
- Trademark PJLink is a trademark applied for trademark rights in Japan, the United States of America and other countries and areas.
- Crestron®, Crestron e-Control®, e-Control®, Crestron Connected™, Fusion RV®, Crestron RoomView® and RoomView™ are trademarks or registered trademarks of Crestron Electronics, Inc. in the United States and other countries.
- DICOM® is the registered trademark of the National Electrical Manufacturers Association for its standards publications relating to digital communications of medical information.
- HDBaseT™ and the HDBaseT Alliance logo are trademarks of the HDBaseT Alliance.

All other trademarks are the properties of their respective owners.

Warranty and after-service

If an abnormal operation (such as smoke, strange odor or excessive sound) should occur, stop using the projector immediately, then turn off the AC power, contact the dealer or service.

Otherwise if a problem occurs with the projector, first refer to “Troubleshooting”, and run through the suggested checks.

If this does not resolve the problem, please consult your dealer or service company. They will tell you what warranty condition is applied.

DUKANE CORP AV SERVICE DEPT
2900 Dukane Drive
St Charles, IL 60174
800-676-2487 / 630-762-4032
Fax 630-584-5156
avservice@dukane.com
www.dukaneav.com